

-> % , =ô z »

RG-IBS6120(E)LoRa *1

† ÍÏ yV1.34

cUV_XOMNZ jHài

copyright © 2021 K@ §5•5

+%) \. " ú \ > , ' 0 7 s Y Ä

Z Ç `K@ §5•5 , ' -M'Aè È+ } ¼ Z ê = Ç + ... é ? F' ?) \. " , ' G 6 µ é F ~ G F > | = f Ä ^ ... Ä 7 - Ä
i Ä P Ý Ä 6 + B @ ! B @ 0 Ä 6 ! ~ G F G 6 + X ¾ v J + X F D Ä



: w j K @ § 5 • 5 , ' v 7 Ä

\. " ú , ! p 9 v 7 F # ¼ v 7 È + a 4 8 , ' p 9 ê 9 Ä

Ø p C] , ' x ñ Ä = Ñ F (© W 1 y Ä v J 8 < ¼ ! n , ' 4 Ö • È \. "] y F , ' ~ G F G 6 x ñ Ä = Ñ F (© W 7 - = X Ø , ' C]
F ~ + X 9 3 \$ { µ Ä L " M Ž 8 < 9 4 Ö È È K @ § 5 • 5) \. " µ é = Š + ... > / j F U / j , ' > F A ñ Ä

+ a ¾ x ñ (x \ w 4 x F ! Ï È \. " µ é J = È O F > | \$ à Ä K @ § 5 • 5 + % X " Ñ 9 + ... F J . F 6 5 / j , ' ö å ;) • µ é
F > | i , ' s Y Ä

\ { ¼ ö Õ E j ~ + X 7 , Ä K @ § 5 • 5 X 5 F É \ { ¼ & " m È A ñ ! µ é ö . ž M • È v ! = . ž { ¼ µ é ¼ ~ " Ñ 9 K I B F F ‡ % ? È
\ { ¼] , ' p 9 Ÿ • = ' @ + ... > / j F Ç / j , ' ö Ä

OBR Ø^-XK@ §5•5x ñ È \ {¼ j Ø È ¶B 4ö,´ .œ &¹>õ 7 ‡ Ä

\ { ¼ k?± û4ý ¶ x ñ X Ì7- : ¼(TM*6 :,´ 0 È(© W È È ¶¹>õ!•PÔ Ã uLì ÂL" Ã°_?õ l È ú+e56 ¼F Õ ~,´?õ l ¼
^-X ö l ÄF2+X ¾ #) :F µ éF >| ¶@ D X ¹>õ ¼5\$ Ô5•5 .œ & éM' § 9 0 Ê4ÿP¼,´+X g Ä< & w ÊB !n x ñ ,´+X gÏ.
-(£_B ¼² % Ä

K@ §5•5 È é5•1 Ö <http://www.ruijie.com.cn/>

K@ §5•5 ¢7- Ò = Ö <http://ocs.ruijie.com.cn>

K@ §5•5 È é5•1 = Ñ > _ 1(x ‡ Ö <http://www.ruijie.com.cn/fw/>

7×24 ? & ° _ = Ñ' 4ï Ö 4008-111-000

K@ § 4ï Þ œ G ' ÖK@ § 4ï,©0

K@ §5•5 °_Aê ‹ Ö <http://bbs.ruijie.com.cn/portal.php>

h?ñL NÈ L3R Ö<http://www.ruijie.com.cn/fw/wt/>

K@ §5•5 °__ 1 > ýO, 1á Ö 4008111000@ruijie.com.cn

\ - G÷+X 4/ýGÂ- 7 •>~j X ý ÇEE÷0;] ÄB (© [# ?,´ é ÈF È 7 ,´ ? y²; Ö

1

RG-IBS6120(E) LoRa LoRa CLASS A/C 2G/3G/4G
 LoRa 470MHz~510MHz

1.1 RG-IBS6120(E)

LoRa CLASS A/C	
	LoRa China, 470-510MHz
	LoRa
	POE

11b -91dBm(1Mbps) -88dBm(5Mbps) -85dBm(11Mbps)

11a/g -89dBm 6Mbps -80dBm 24Mbps -76dBm 36Mbps -70dBm 54Mbps

11n -83dBm@MCS0 -65dBm@MCS7

LoRa -146dBm

1.2 RG-IBS6120(E)

RG-IBS6120(E)

1-1

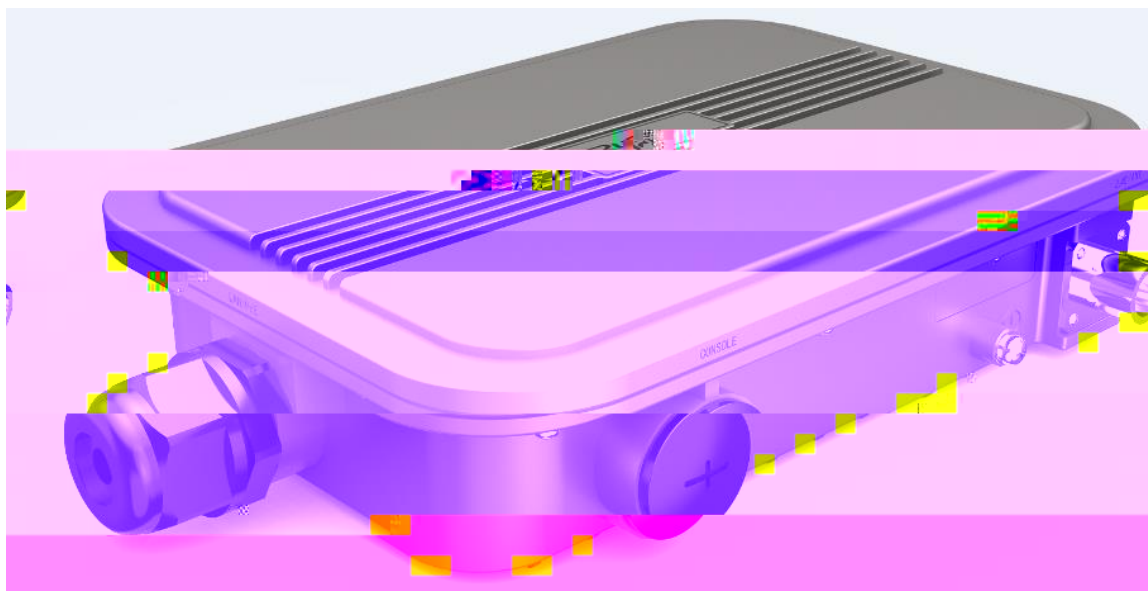

1-2

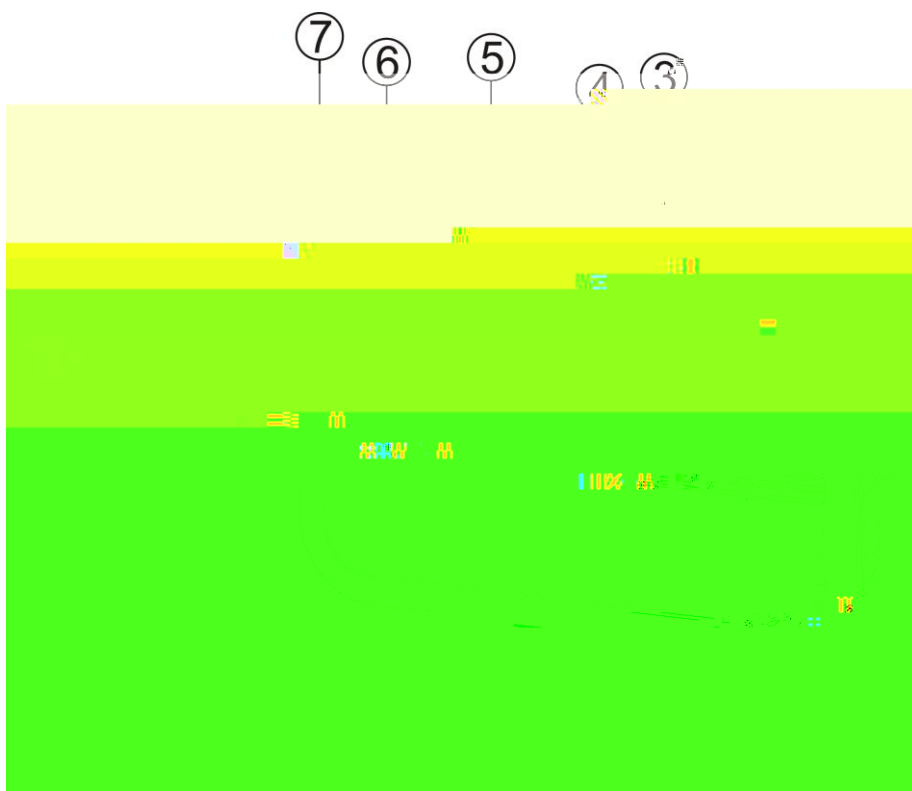

3G/4G/ANT 3G/4G

LORA/ANT1 LORA 1

BT/ANT

2.4G/ANT 2.4G

GPS

LORA/ANT2 LORA 2

SIM SIM

LAN/PoE 10/100/1000Base-T

ETH1 /48V PoE IN

RJ45

1.3 RG-IBS6120(E)

SYS			
LED1			LoRa
			LoRa
			LoRa
LED2			WiFi
			WiFi
			WiFi
LED3			3G/4G
			3G/4G

2

2.1



RG-IBS6120(E)



2.2



AP



500m



2.3



2.4



AP



2.5

RG-IBS6120(E)

2.5.1

-

-

RG-IBS6120(E)

-

RG-IBS6120(E)

2.5.2

RG-IBS6120(E)

2.5.3

RG-IBS6120(E)

-

-

-

RG-IBS6120(E)

-40°C-65°C	10%-90%

2.5.4

(μ m)	0.5	1	3	5
/	1.4×10 ⁷	7×10 ⁵	2.4×10 ⁵	1.3×10 ⁵

	mg/m ³	mg/m ³
SO ₂	0.2	1.5
H ₂ S	0.006	0.03

NO ₂	0.04	0.15
NH ₃	0.05	0.15
Cl ₂	0.01	0.3

2.5.5

- PoE 802.3af/802.3at PoE

PoE

2.5.6 EMI

-
-

2.6

 RG-IBS6120(E)

-

	POE

2.7

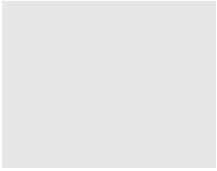

× 1





*1 M5

*4 M6

*2

*2

*1

LORA		1	-
		2	-
		2	-
		2	-
		0	-



3

RG-IBS6120(E)



3.1

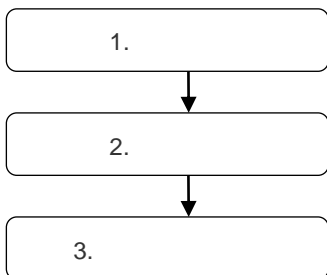

3.2

RG-IBS6120(E)

-
-
-
-
-
-
-

3.3

-
-
-

-
-
-
-
-
-
-
-

3.4



3.4.1

1	M5		4
2	M6		2
3			1
4		2	
5	M6		4

3.4.2

3.4.2.1 5dbi

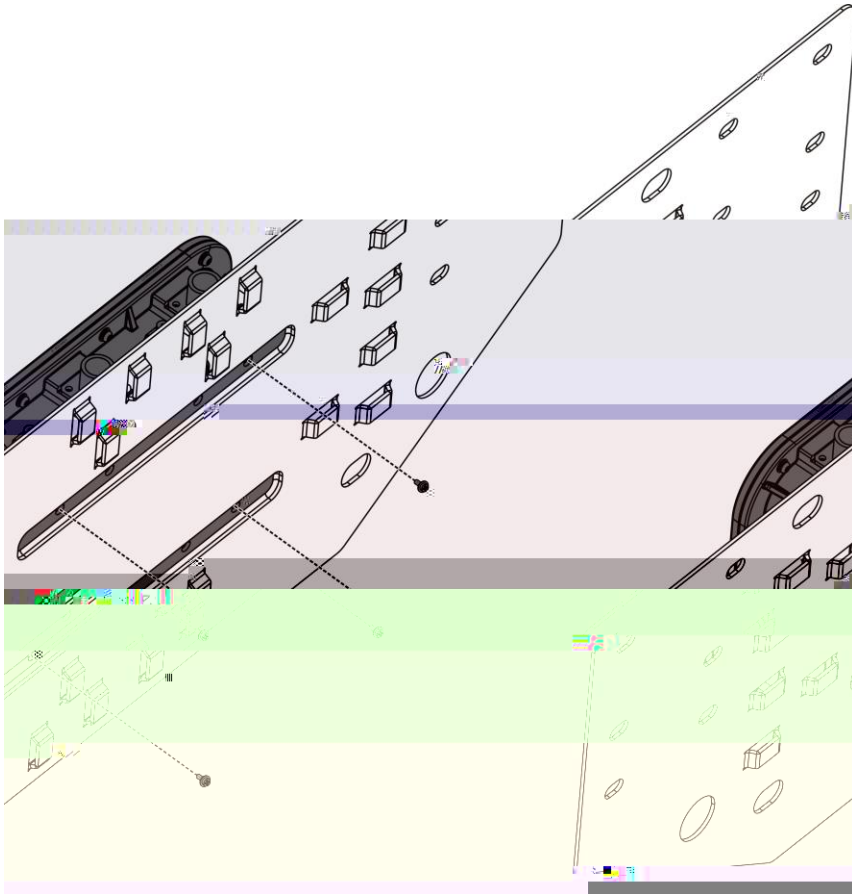

3.4.2.1.1.1

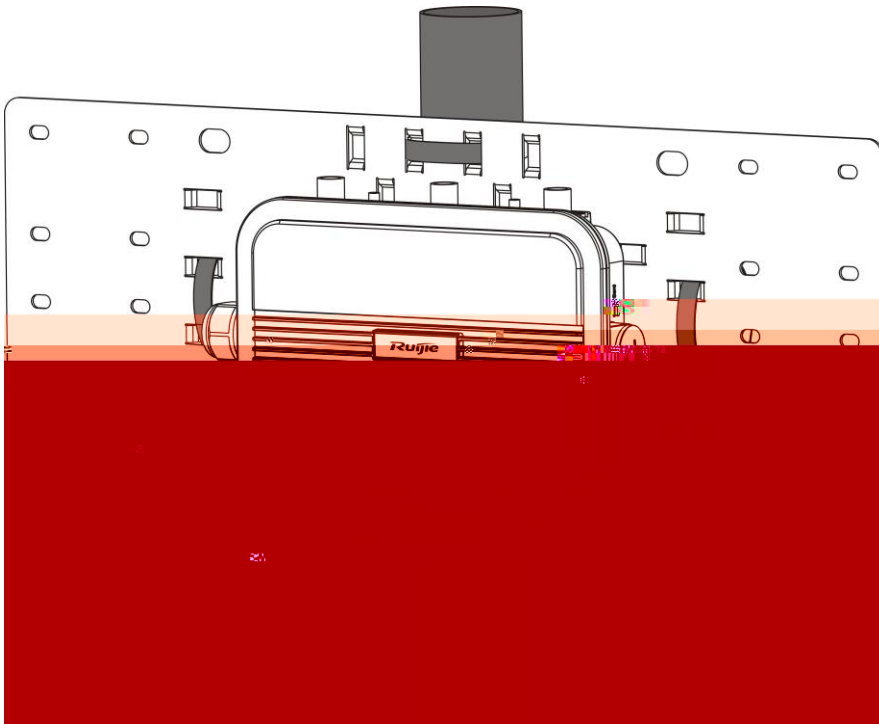

3.4.2.1.1.2

- 1
- 2

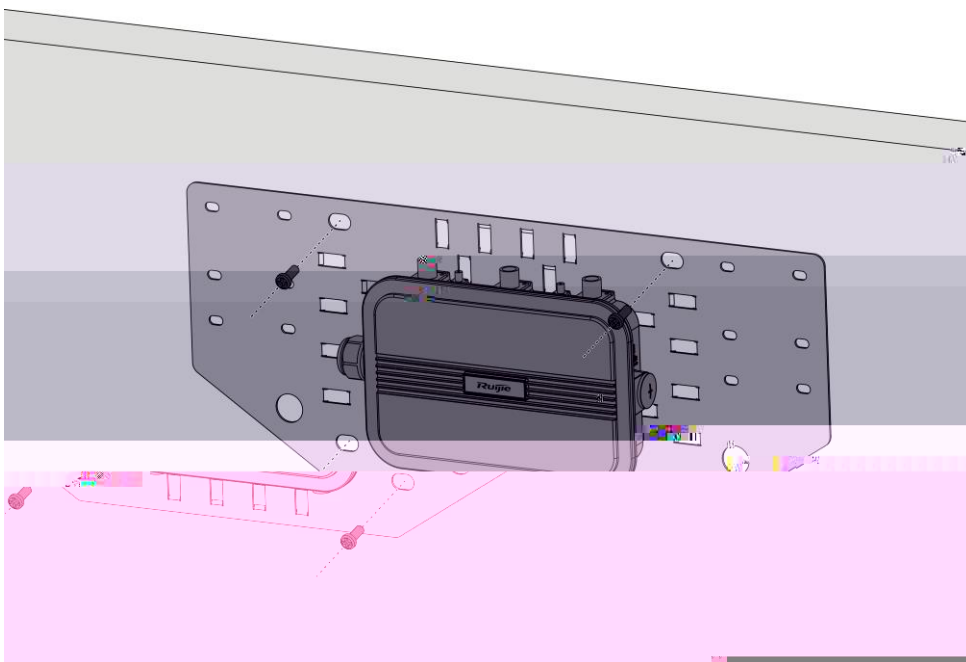

3.4.2.1.2

1

2

2

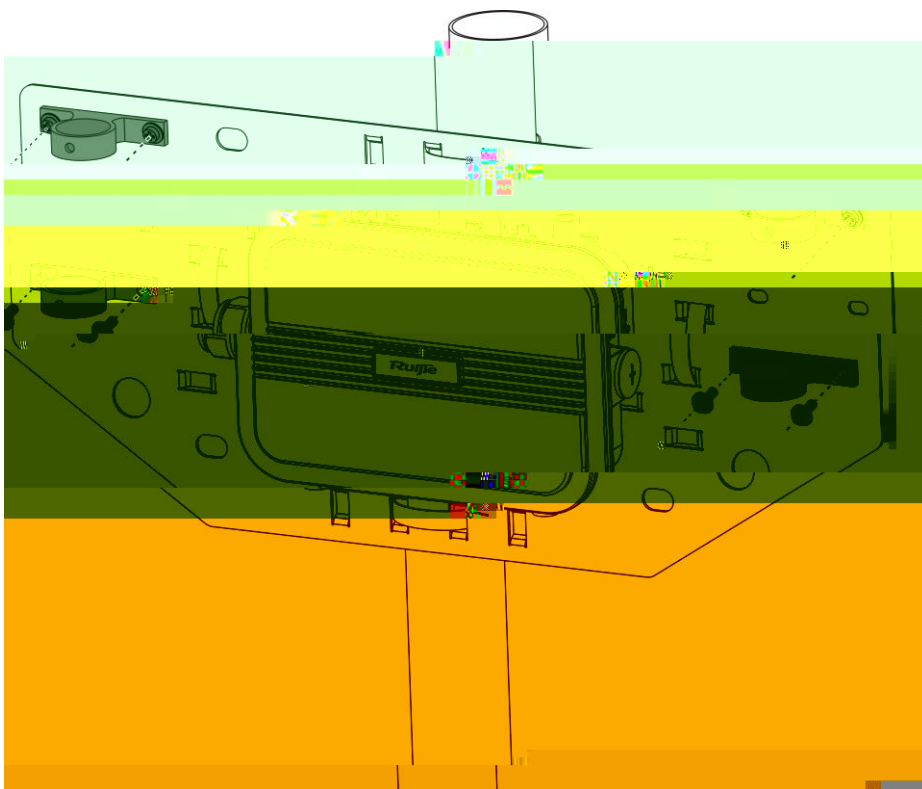

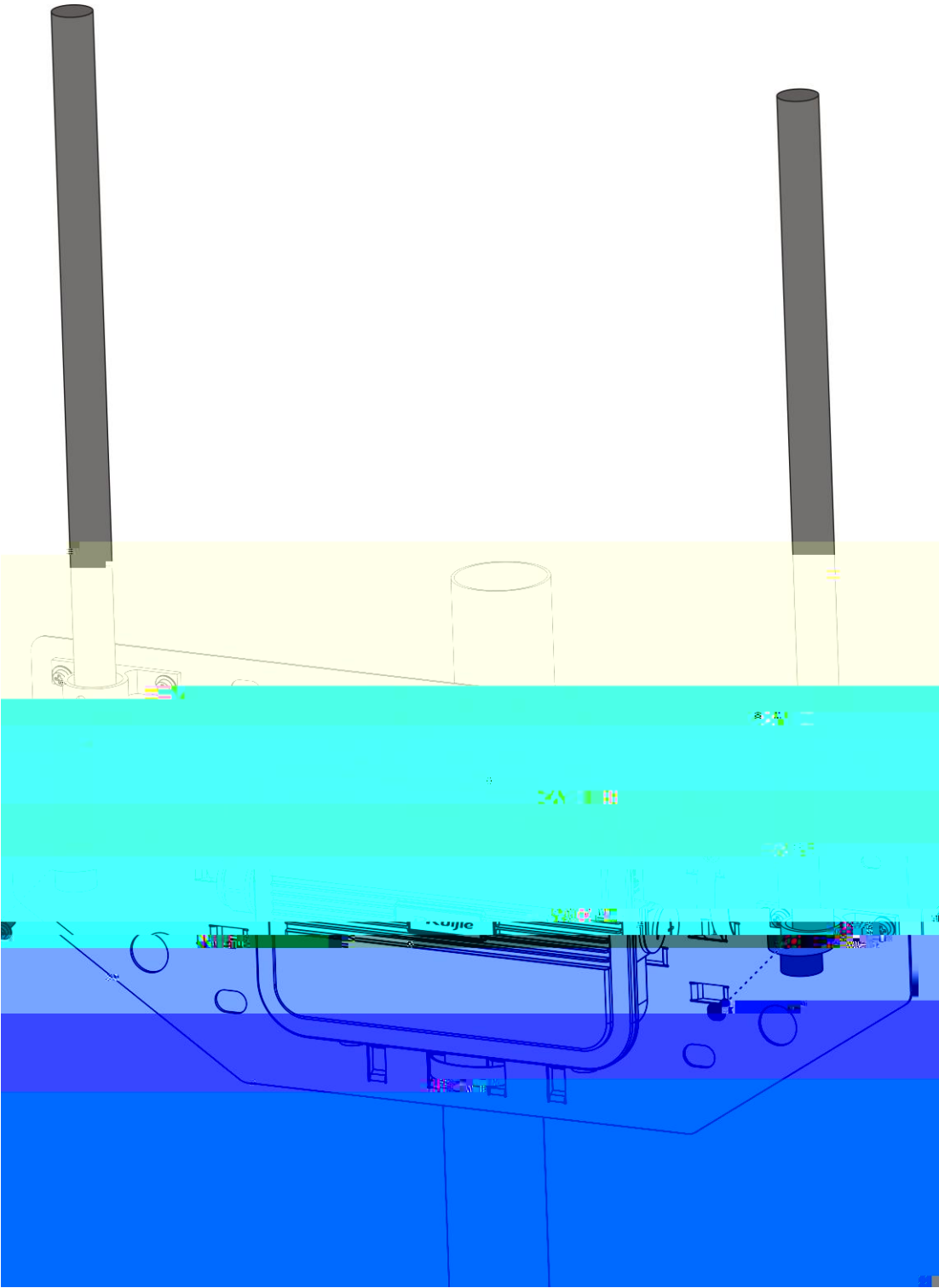

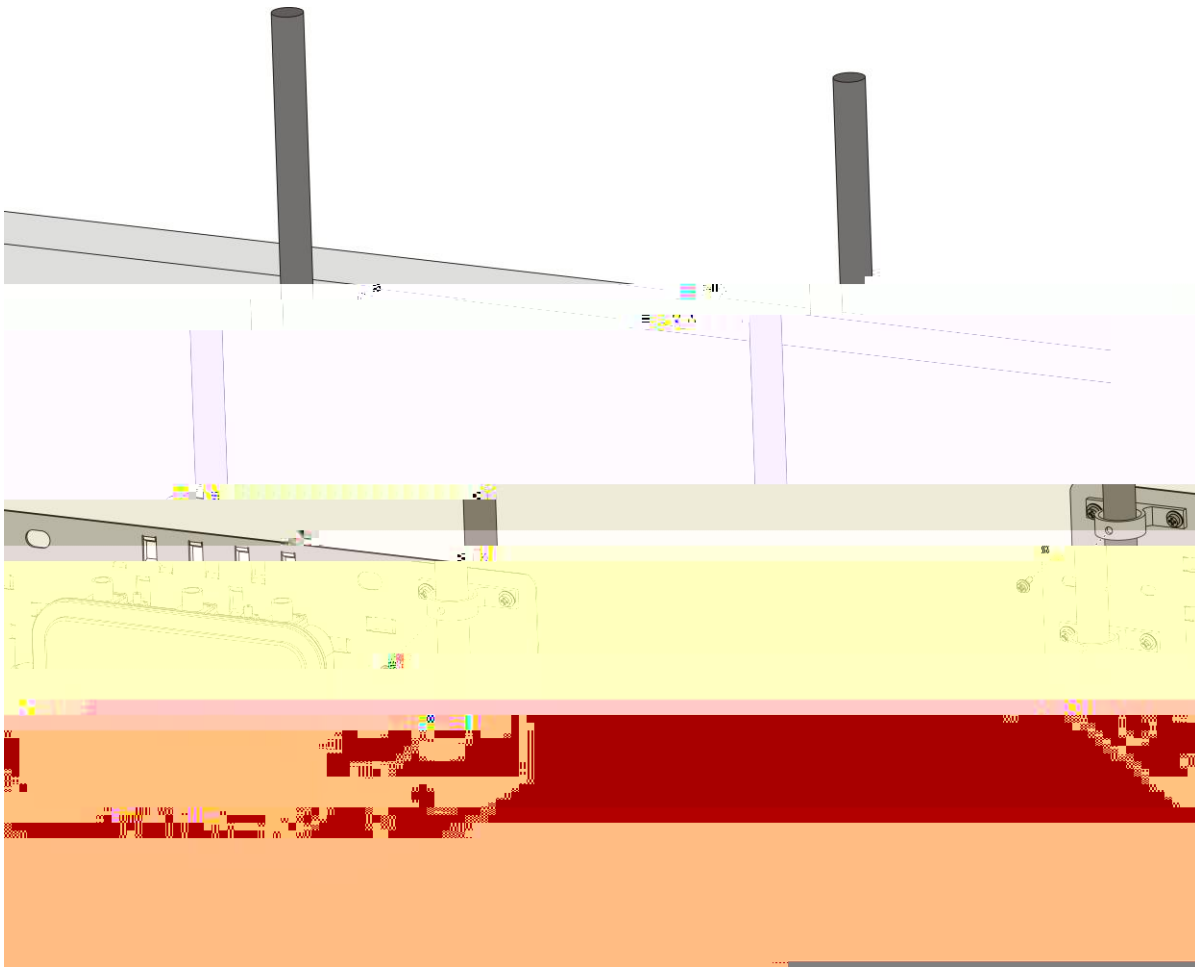

3

GPS

4G

3.4.2.1.3

1 N

3.4.2.2 2dbi

3.4.2.2.1

3.4.2.2.1.1

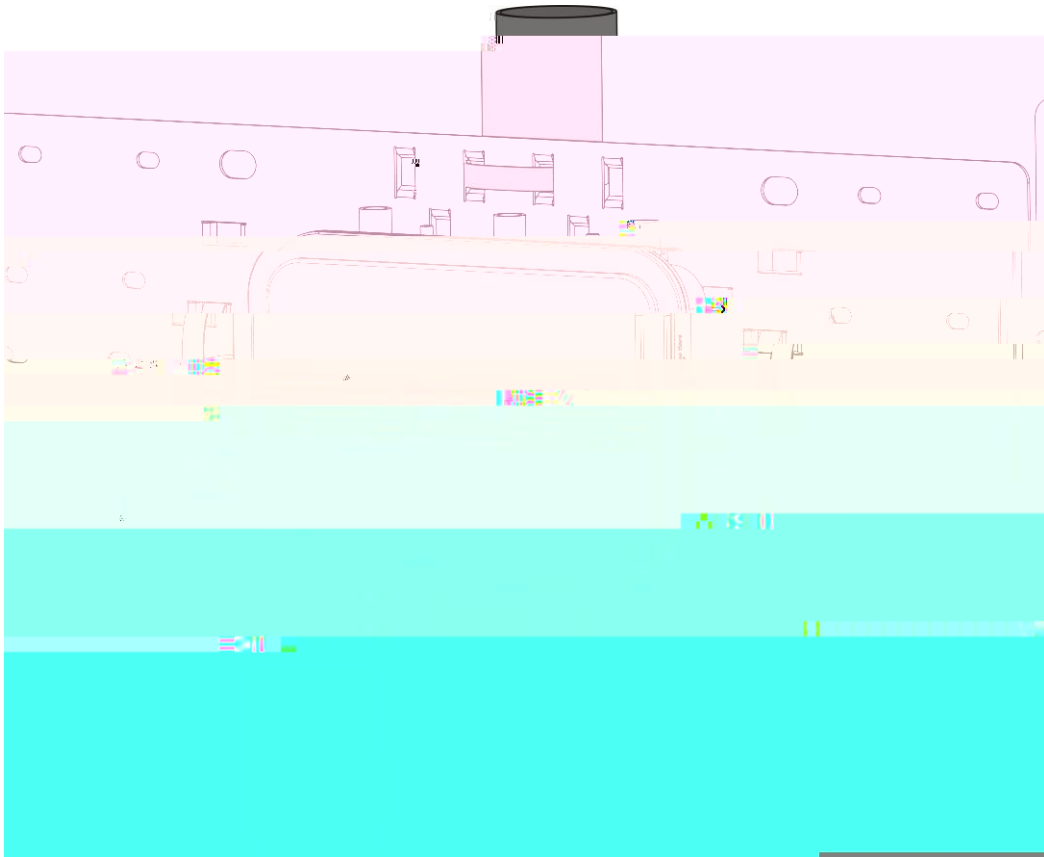

3.4.2.2.1.2

1 4 M5 IBS6120(E)

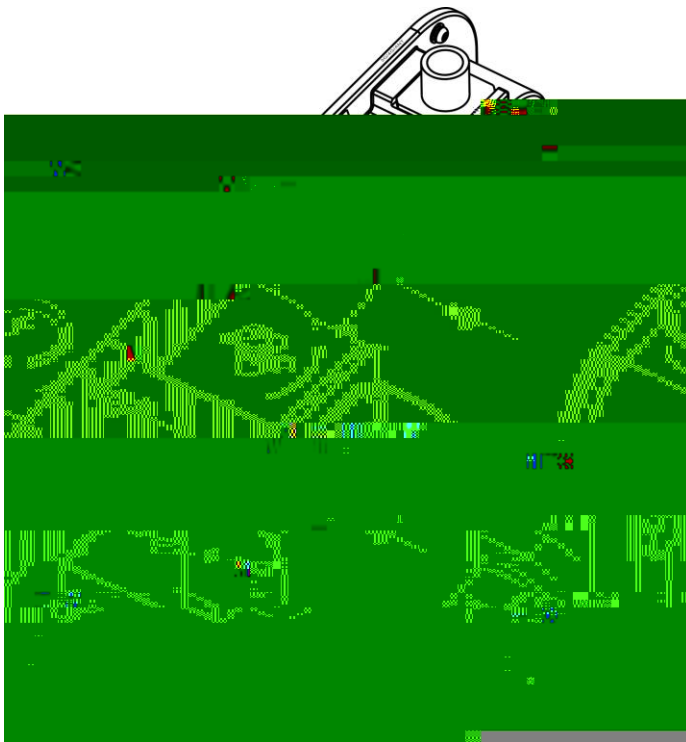

2

2

4 M6

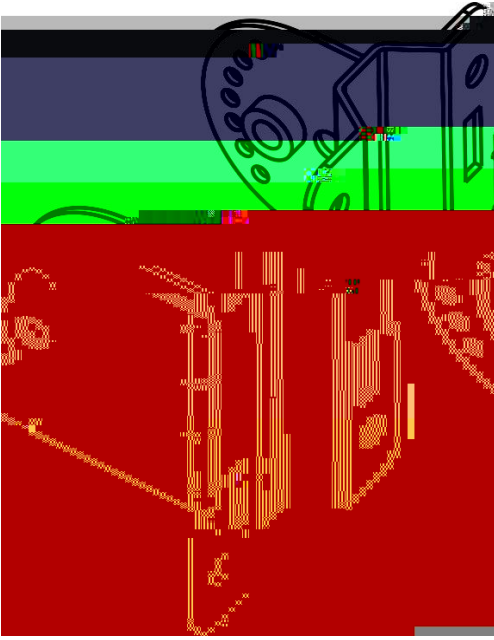

3 2 M6

4 M6

4 M6

IBS6120



4

5

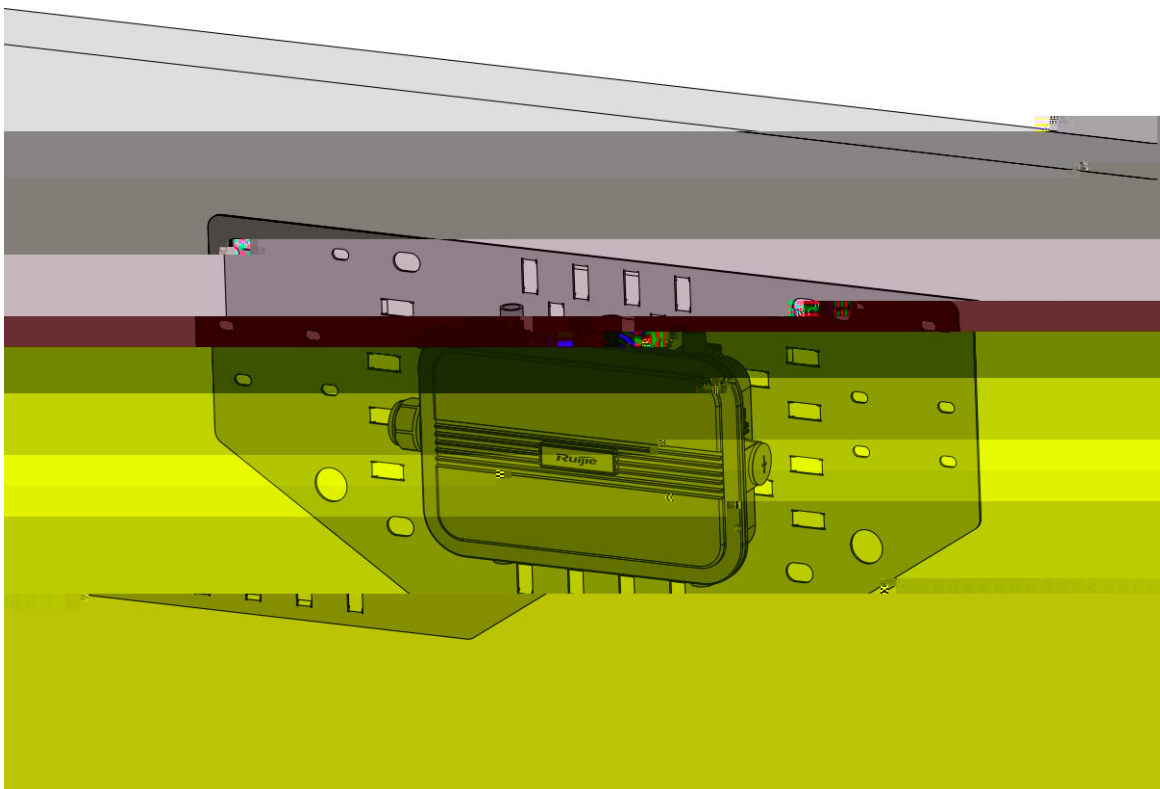
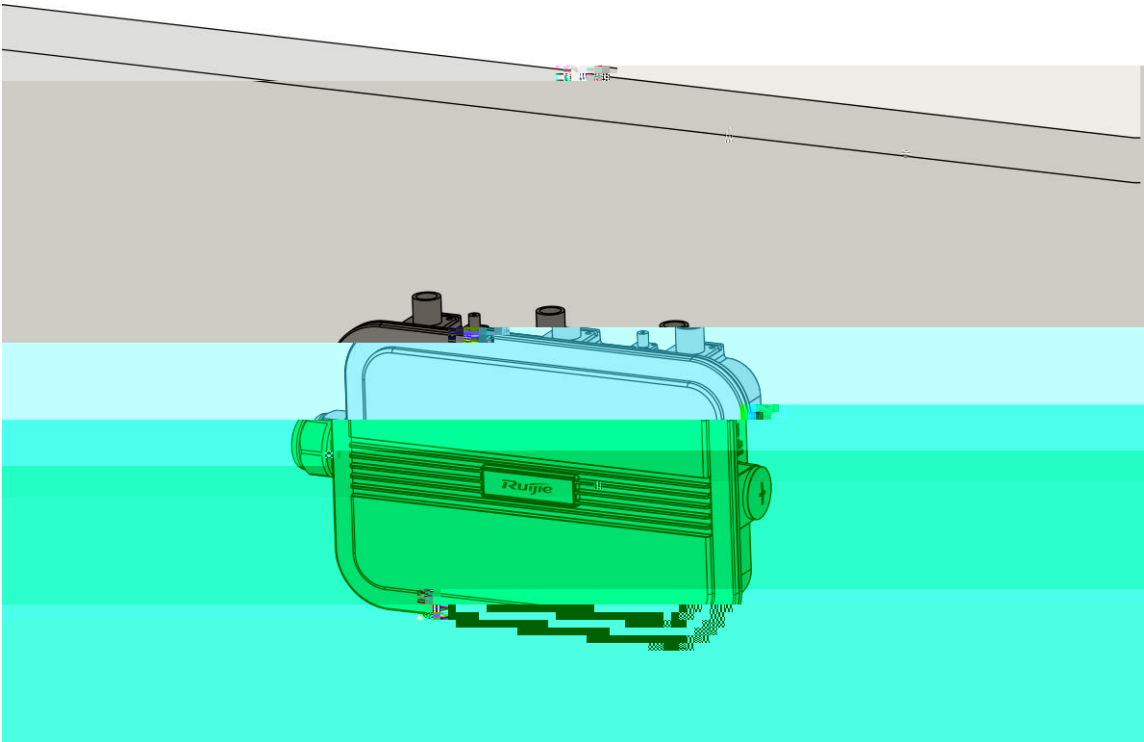

3.4.2.2.2

1 Lora

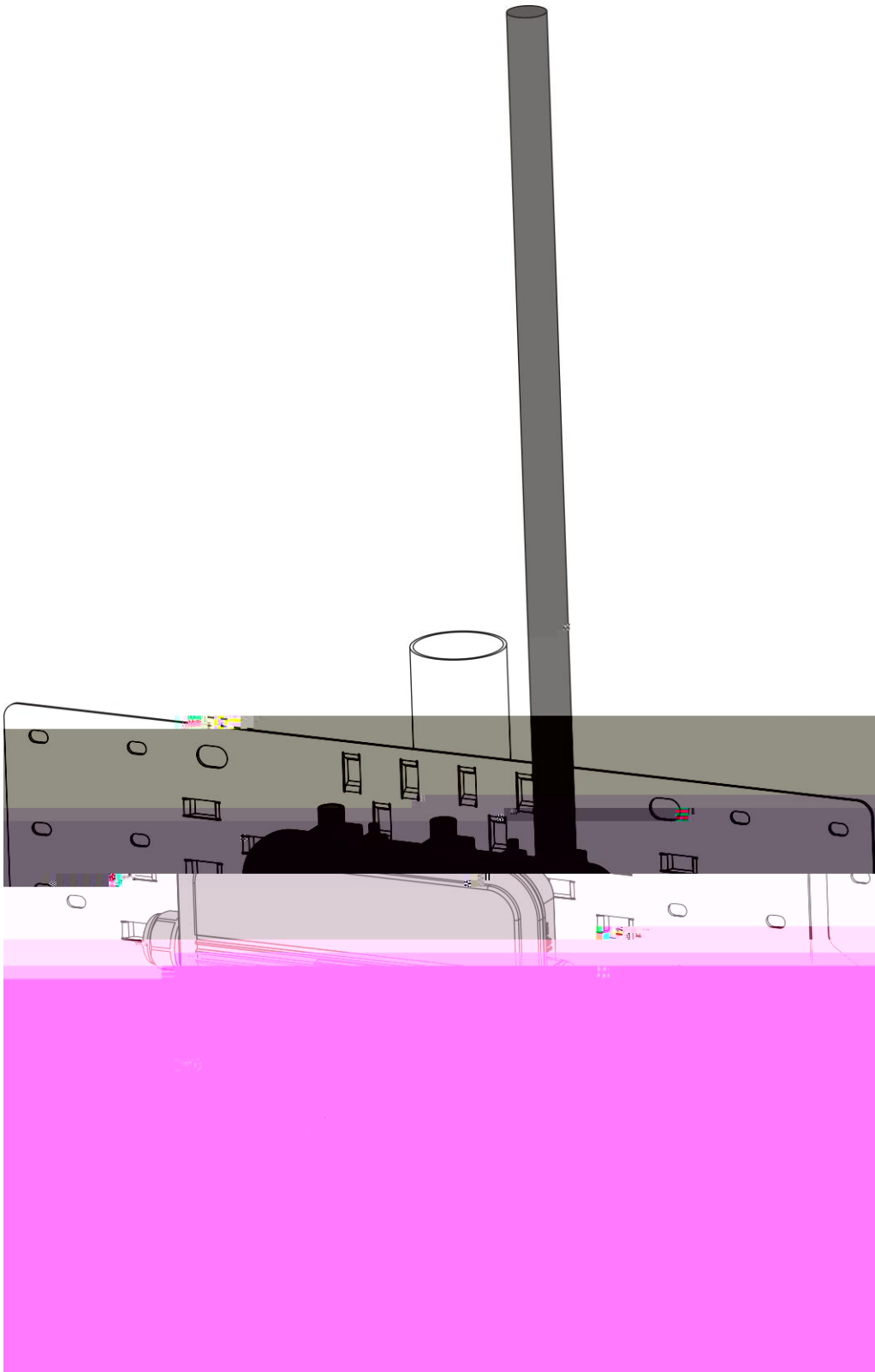

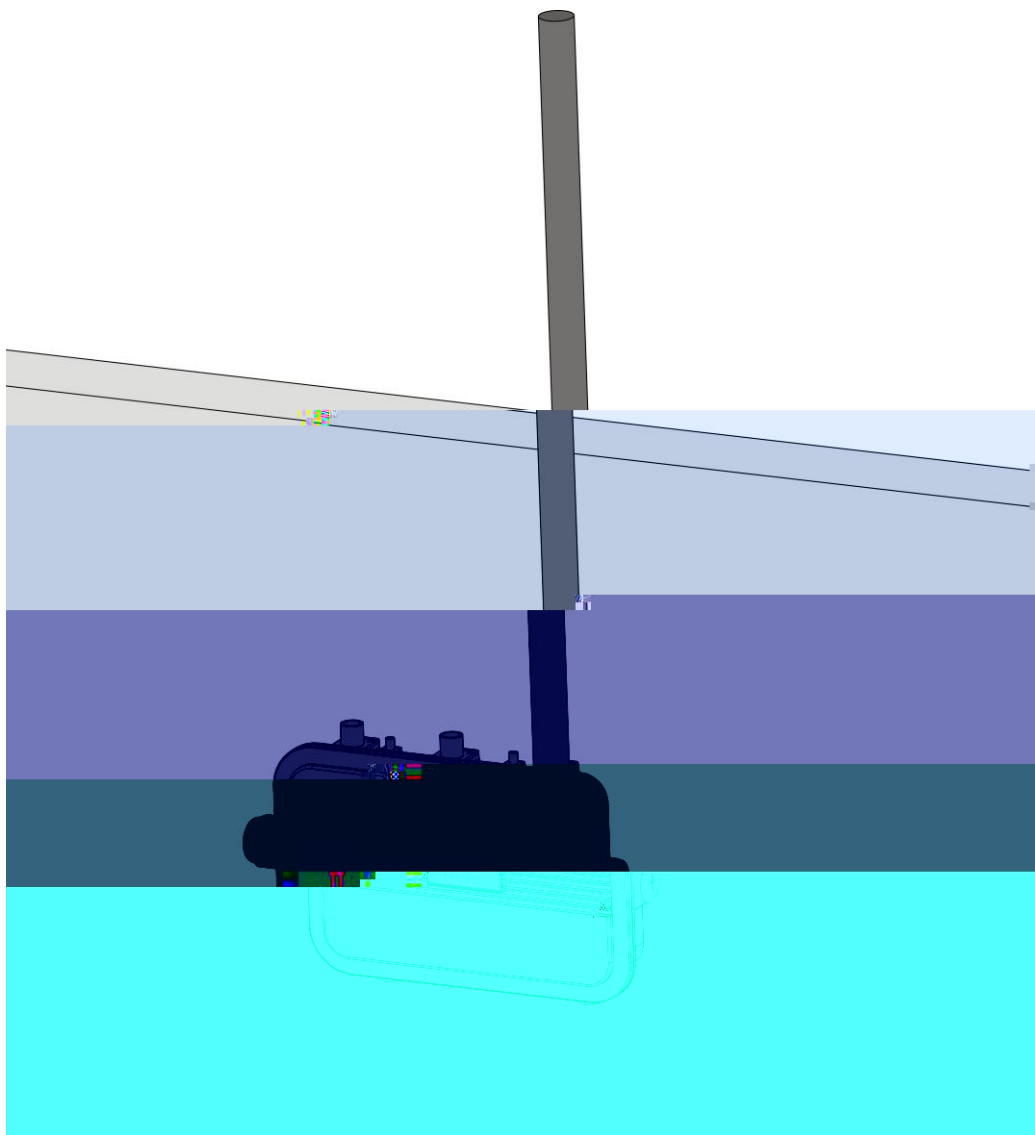

2

GPS

4G

3.4.2.2.3

2dbi

3.5

3.5.1

1

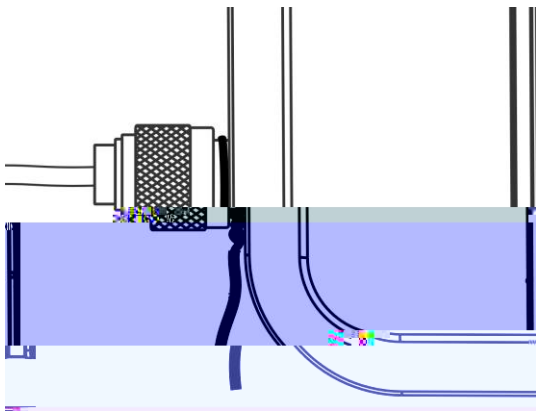

2

1

3

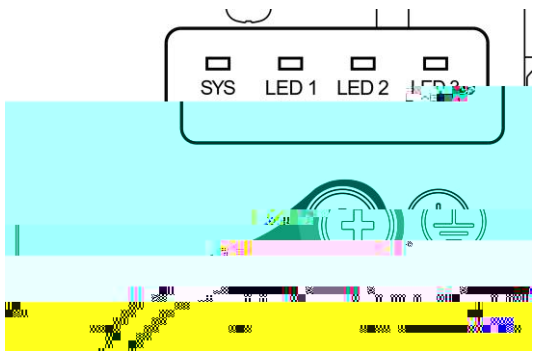

3

AR30N

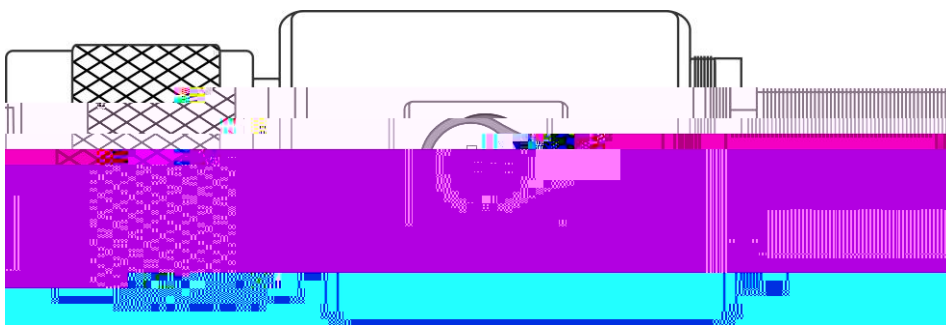

3.5.2

1

2

PG O LAN/PoE POE
A

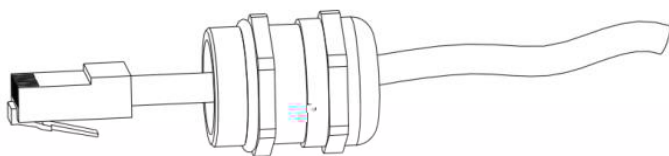

console 9600 8 1

PG PG

3
4

POE

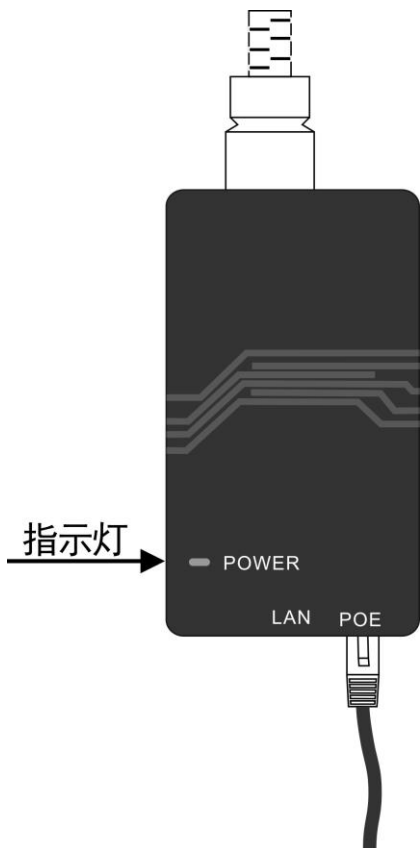

3.7

1
2
3

90°

AR30N

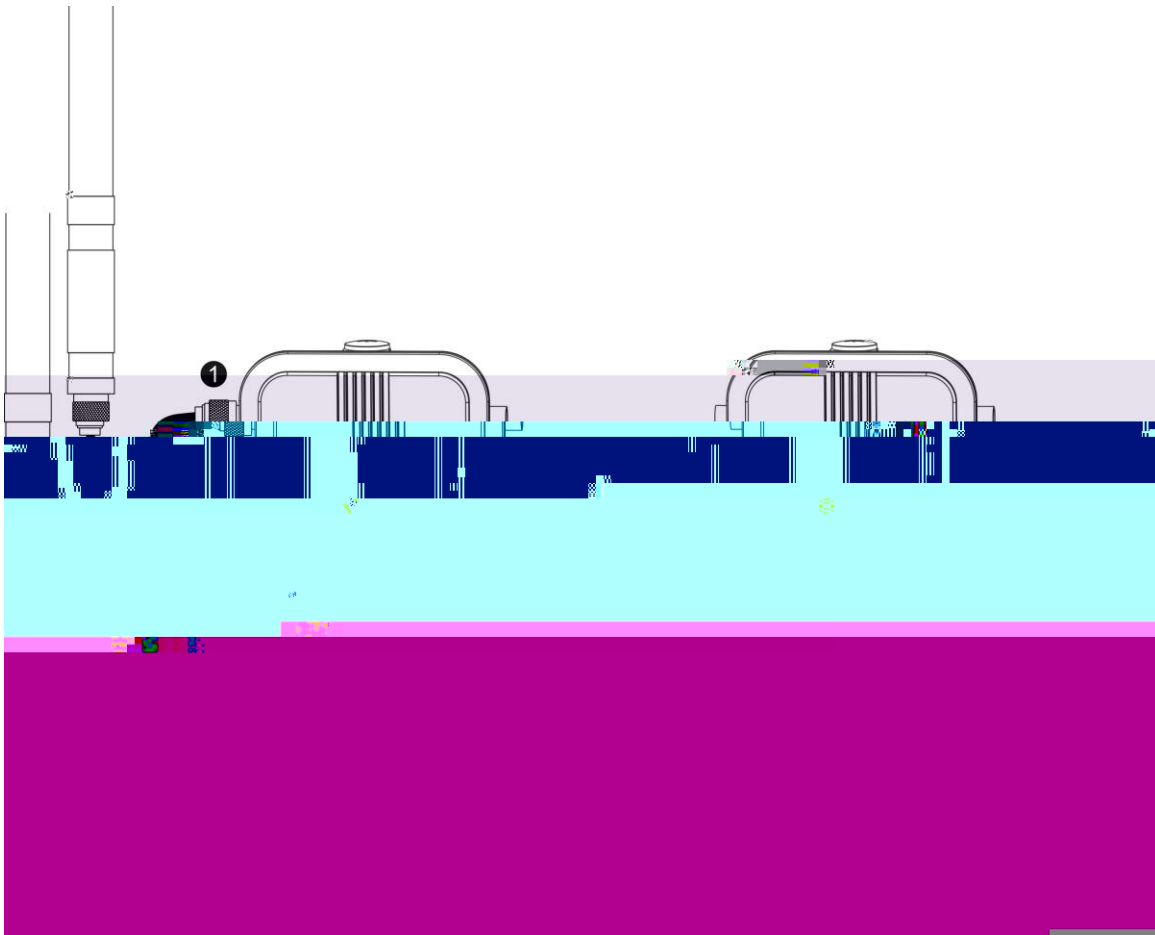

3.8

-
-
-

1)

LAN/PoE

2)

3)

3.9

-
-
-
-

-
-

-
-

4

4.1

PoE

- PoE
- PC PoE

4.2

-
-

-
-

5

5.1

RG-IBS6120(E)

CLI

RG-IBS6120(E)

6

6.1

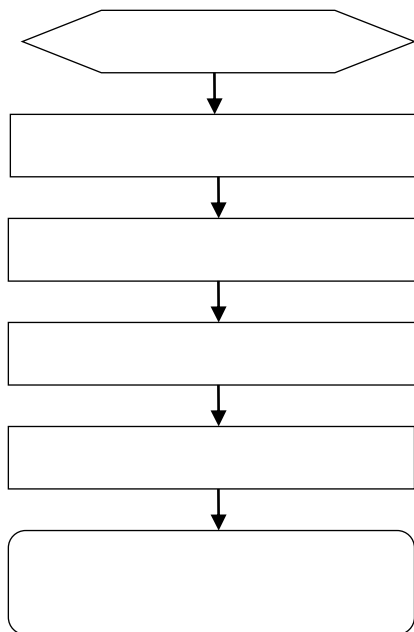

6.2

LED1

- PoE PoE 802.11af

1)

1)

2)

3)

LED1

SYS

SYS

LED1

SYS

SYS

A — —

—

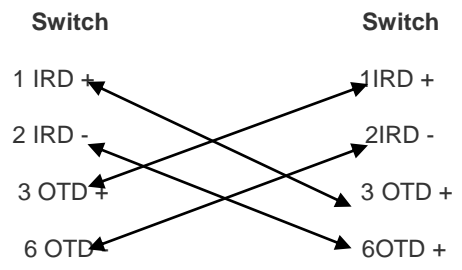
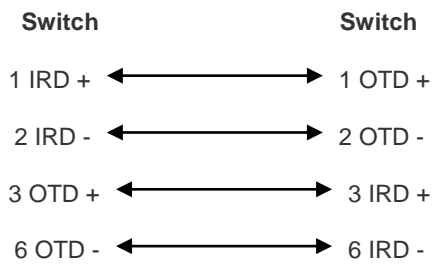

— —

RG-IBS6120

D-2

■

D-3

D-3

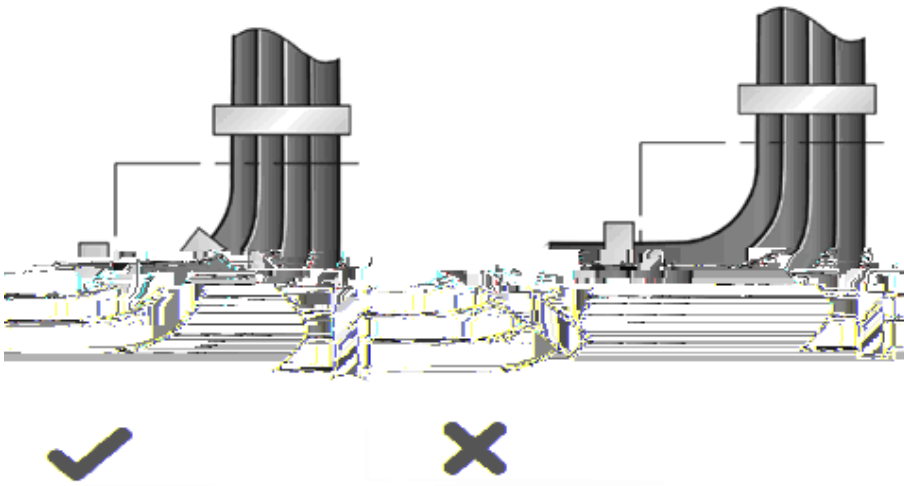

■

■ 220V -48V

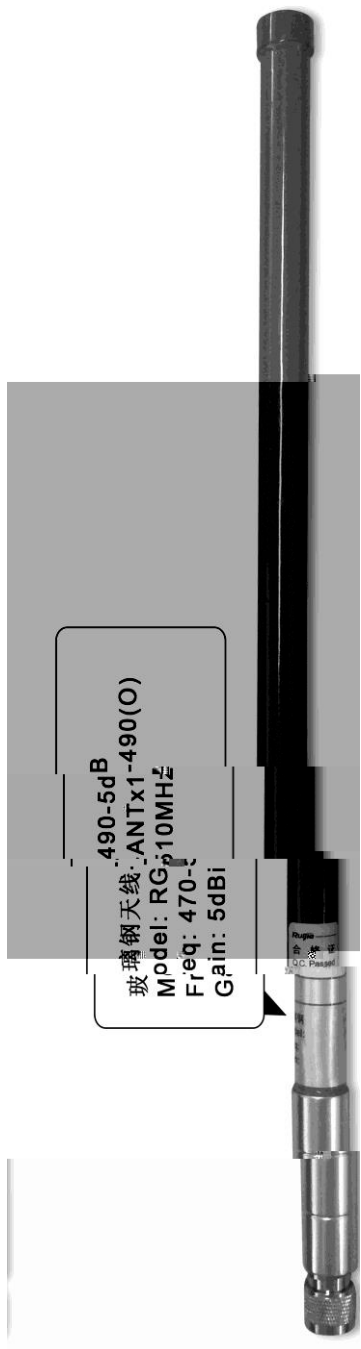

- 2dbi

