

V1.1

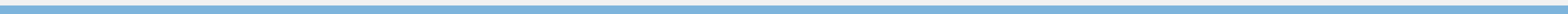







- 1.
- 2.
- 3.
- 4.

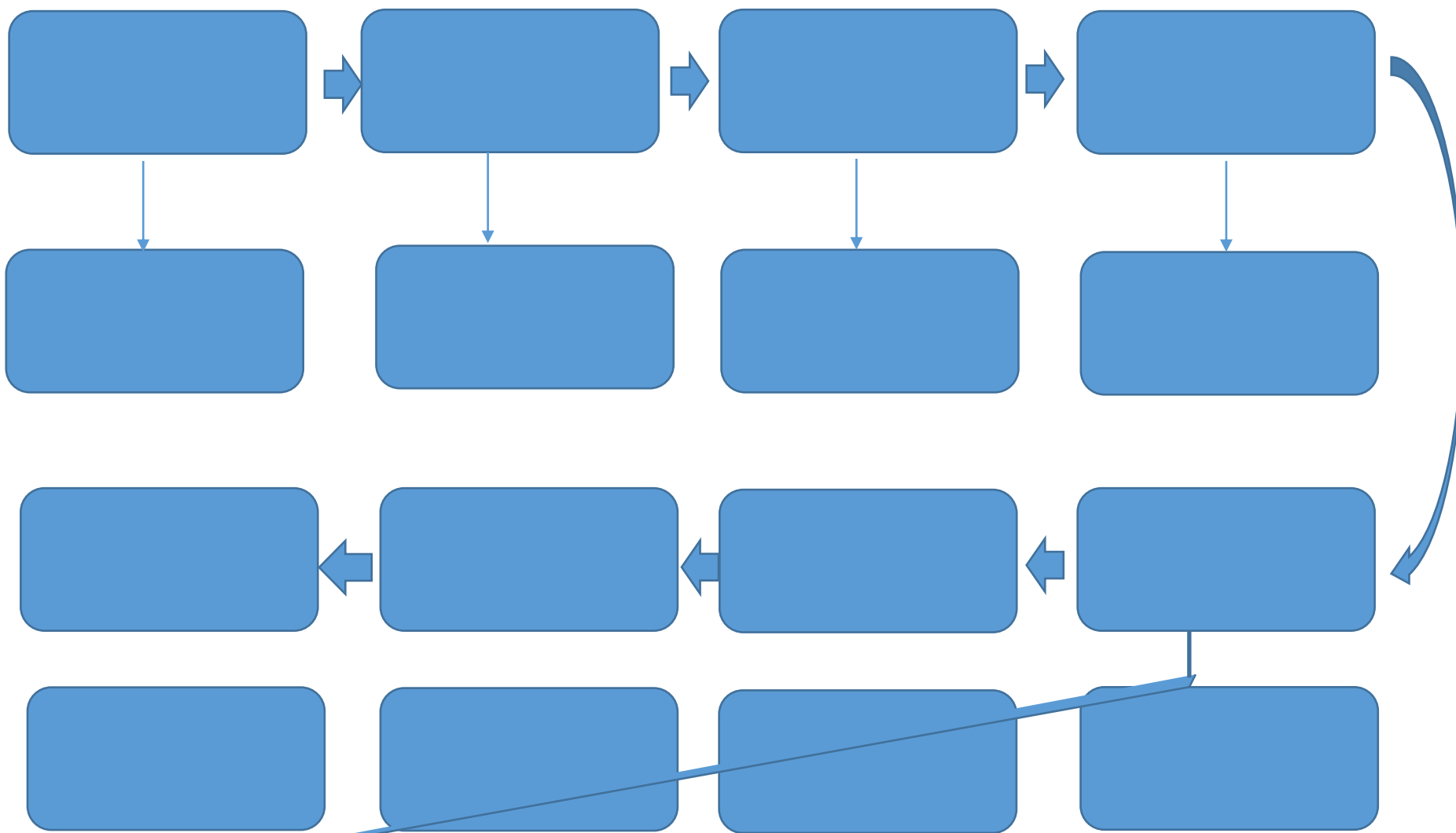



-

G.657 A2

ODTR:



PC
WiFi

PDA
WirelessMon

PC
WiFi

IxChariot
endPoint
FTP

2.4G 5G

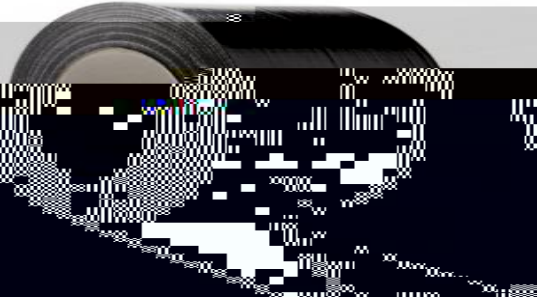
	RVV 2 4	YD/T 1173-2016	12	4	NA
	BVV 2 1		AP	1	NA
			AP	AP	https://item.taobao.com/item.htm?spm=a230r.1.14.15.65d85e7506ueAh&id=623673107776&ns=1&abucket=12#detail
					AM5552-SF(V2)
ODF		LC			NA
		LC	ODF		
		LC		AP	
	G657.A2		AP ODF	AP	
					NA



RG-MAP852-SF AP

30cm

RG-MAP852-SF AP



- 1.
- 2.
- 3.
- 4.

RG-AM5552-SF

1U

1

2

2

RG-AM5552-SF

RG-PA150I-F

RG-AM5552-SF

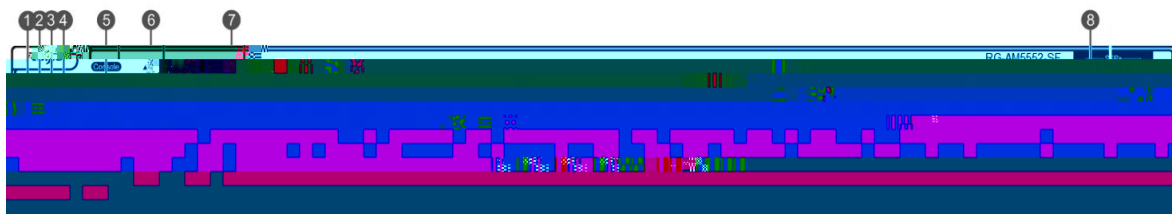

1		7	SFP
2	(PWR1)	8	SFP Plus
3	(PWR2)	9	USB
4	MGMT	10	MiniUSB
5	Console	11	MGMT
6	SFP	12	SFP Plus

RG-AM5552-SF



RG-AM5552-SF(V2)

1U

PA1000I-P-F

1

2

4 56V

172W

RG-AM5552-SF(V2)

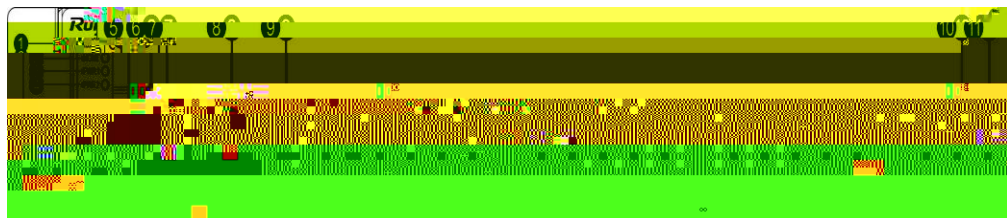

1		7	MGMT
2	MGMT	8	SFP
3	(PWR1)	9	SFP
4	(PWR2)	10	SFP Plus
5	USB	11	SFP Plus
6	Console		

RG-AM5552-SF(V2)

RG-

2

12 AP

200m

RG-AM5552-SF(V2)

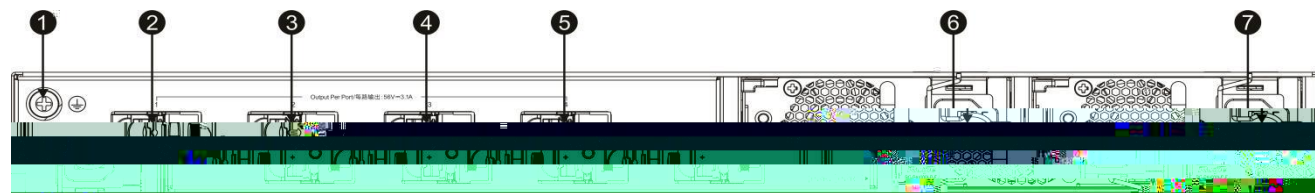

1.	
2-5. 4	
6	2
7	1

RG-AM5552-SF(V2)

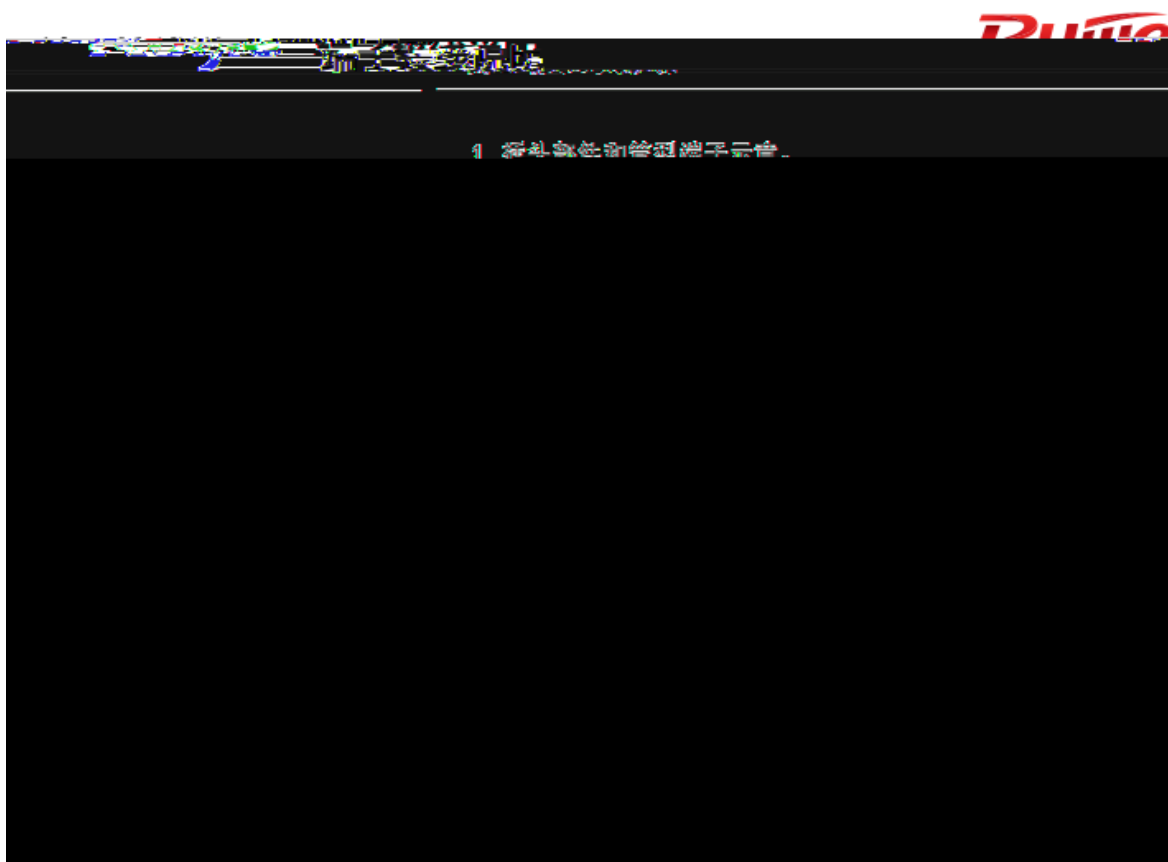

4. 将接线完毕后的4个插头分别插入整机后部的端口内，每个端口最大支持12台微AP。

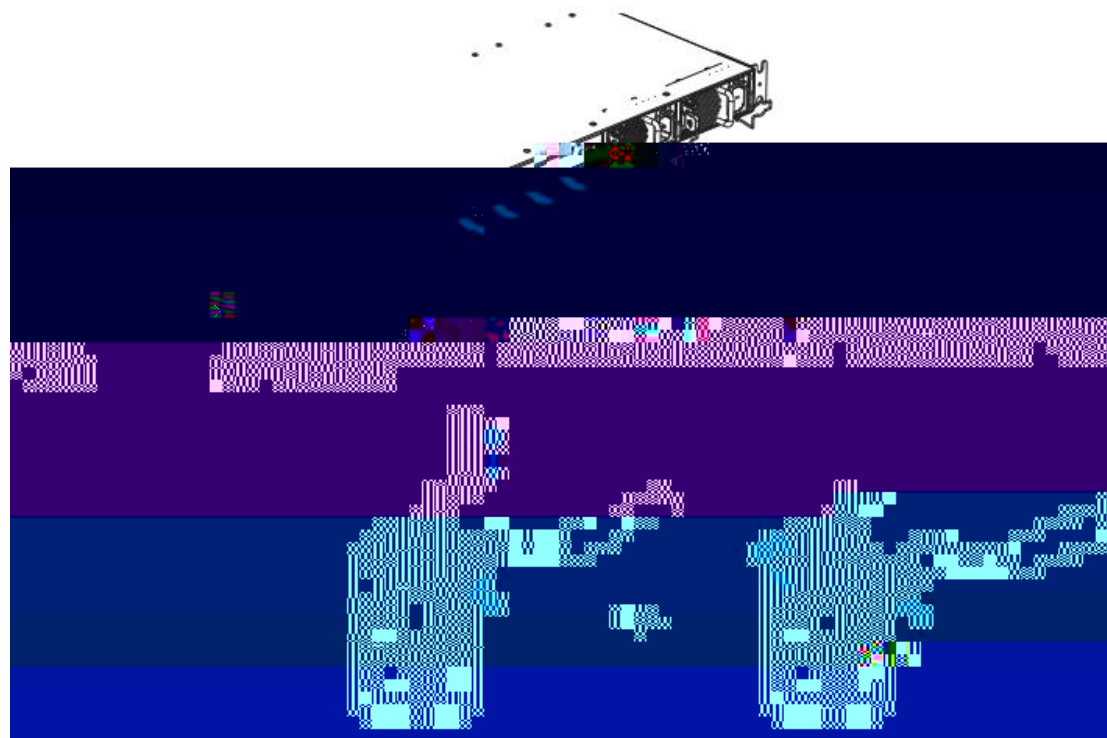



- 1.
- 2.
- 3.
- 4.

48 SFP 4 SFP+ 4 2 2 56V/1000W

12 AP

200

AP

4

AP

1

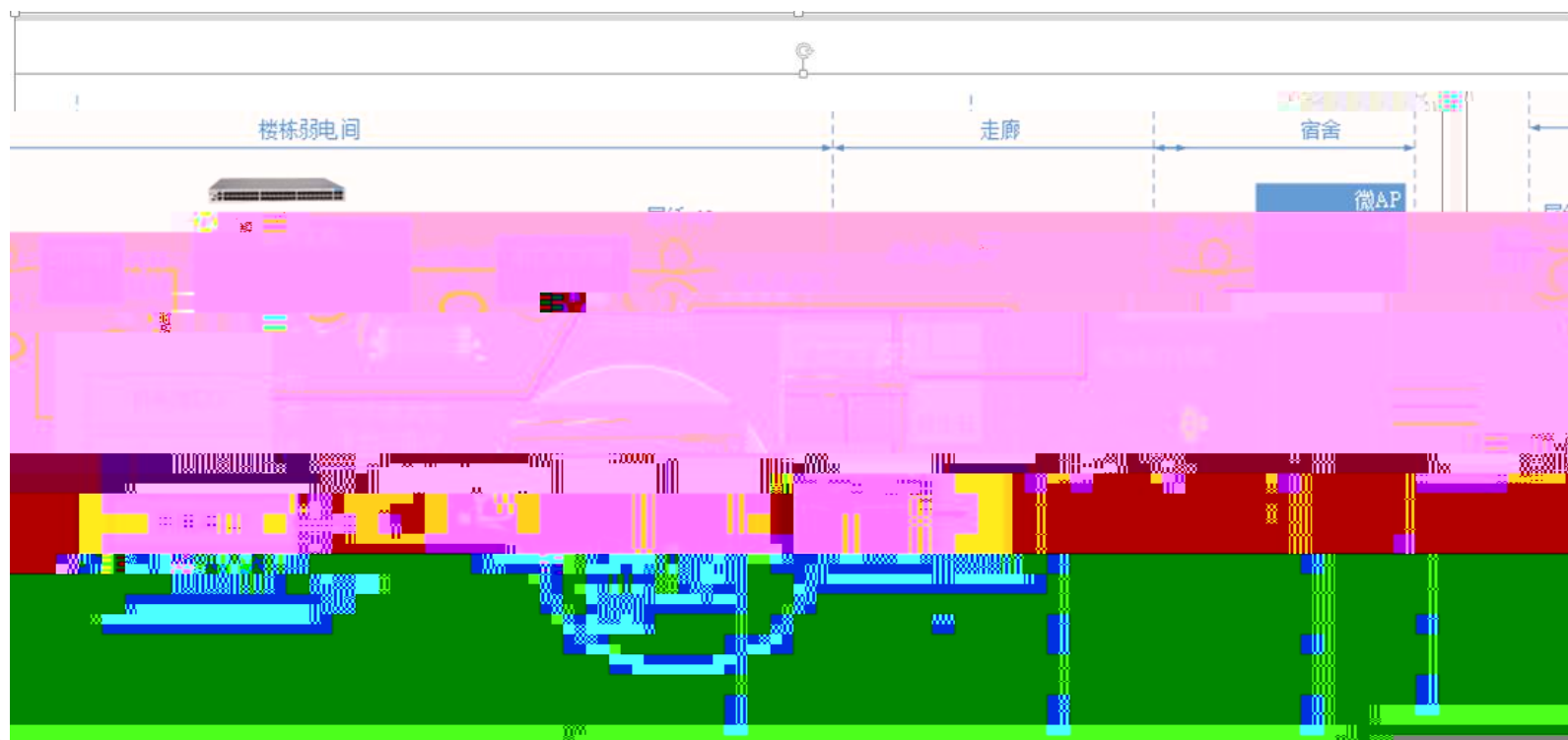

ODF

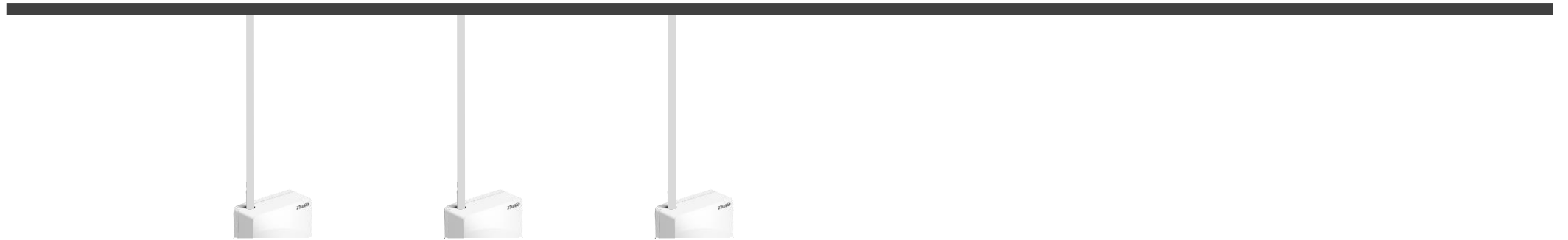

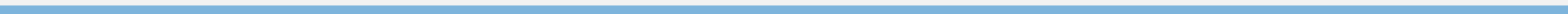



6-8

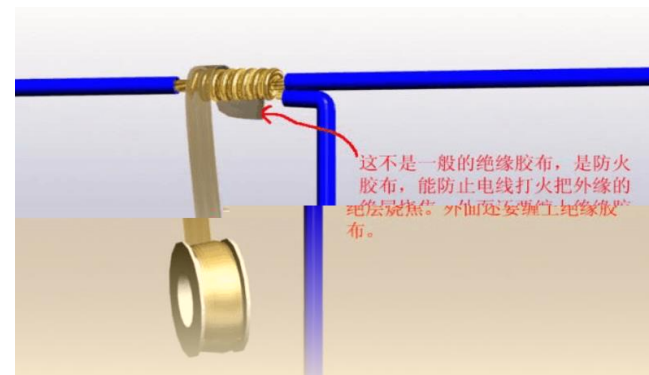
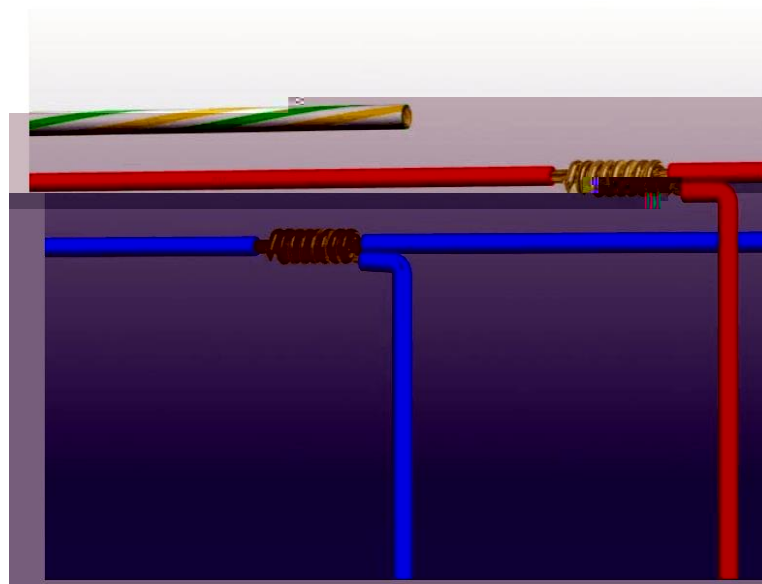

G.657 A2

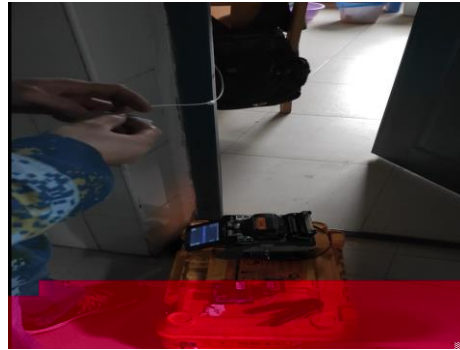

AP

1

AP

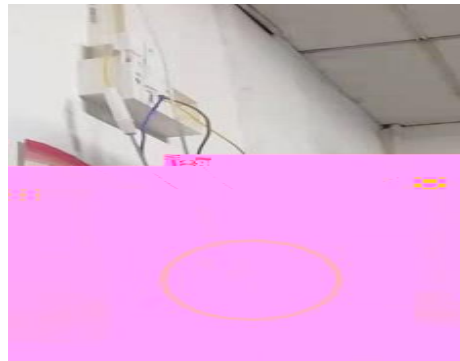

RG-MAP852-SF

86

AP

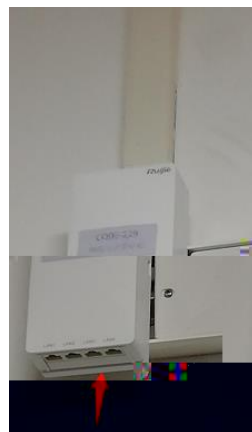
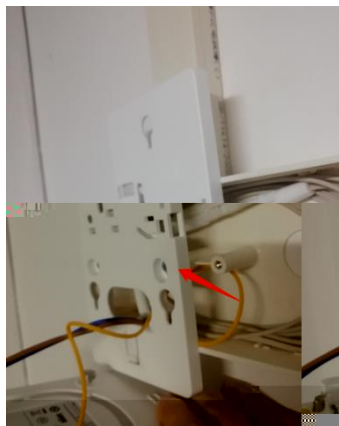

RG-MAP852-SF

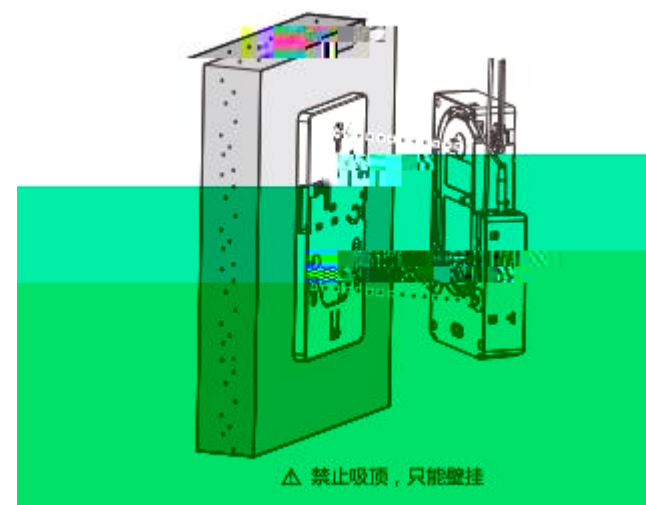
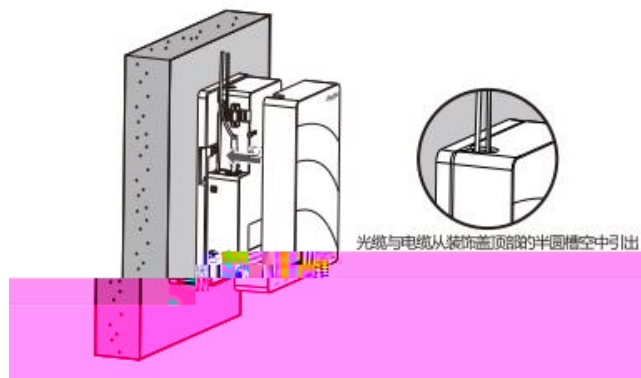
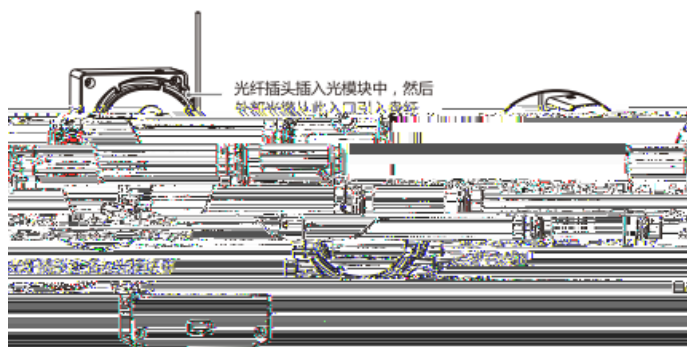



86

AP

AP

AP





- 1.
- 2.
- 3.
- 4.



```
3
4 /*脚本使用说明: ← 查看脚本使用说明, 填写相应环境参数
5 1. 打开CRT并连接登陆
```

AP

AP

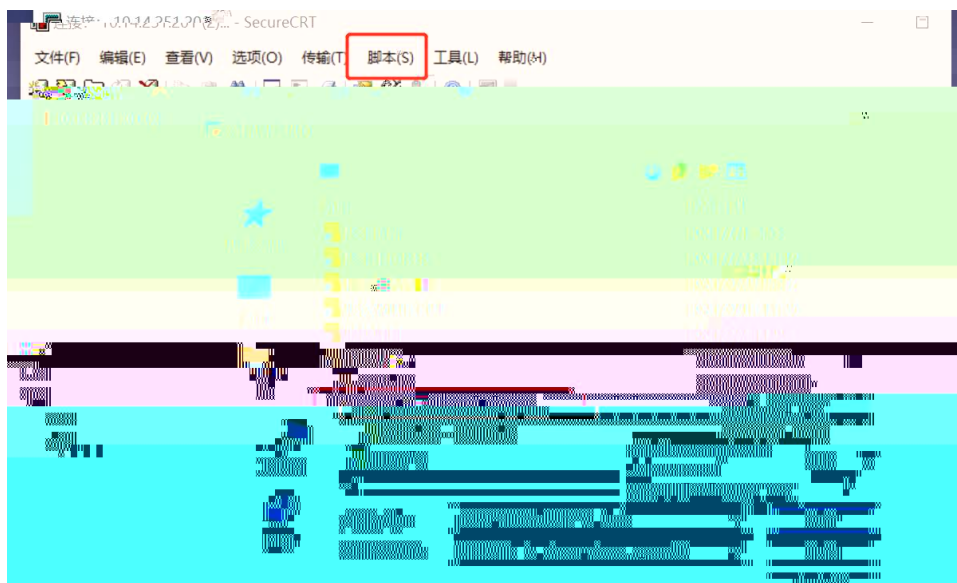

RTR

```
var filePath = 'D:\\'; //必选项：填写结果记录文件的路径—英文路径,如果有子目录的话,必须预先创建好对应的文件目录!!
```



excel

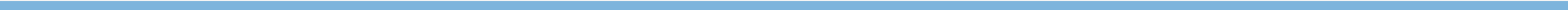

sheet

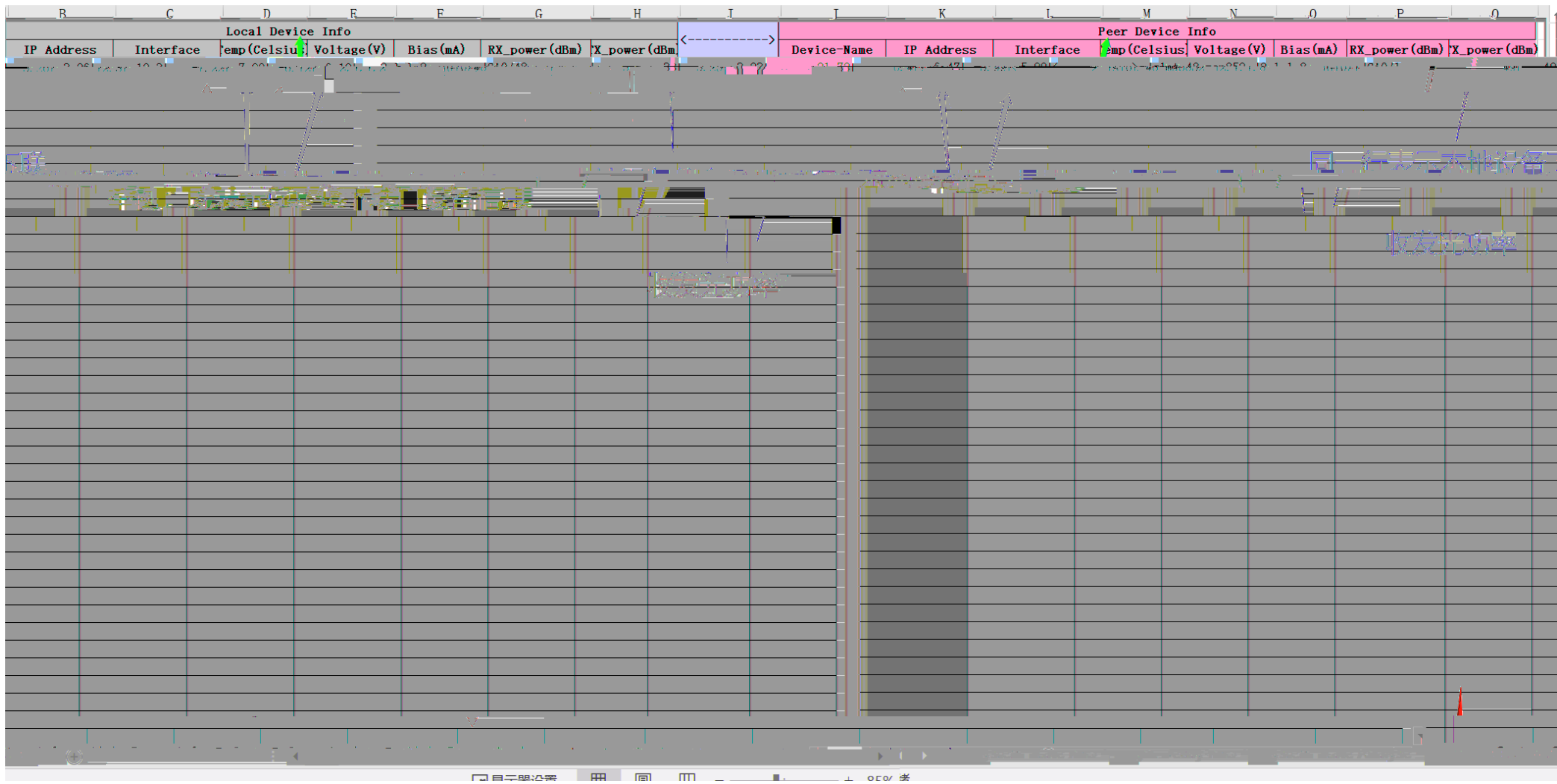



AP

$$= -13\text{dbm} + \text{+ODF} + 3\text{db} - 20\text{dbm}$$

1

2

3



- 1.
- 2.
- 3.
- 4.

1 Link

Link

1

2

3

4

2 RX power

```
am6552-sf-2#  
am6552-sf-2#show int tr d  
-----  
interface GigabitEthernet 0/0/0/0  
-----
```

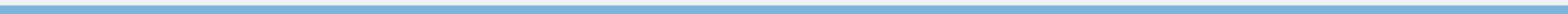



THANKS

29

100036

Office Tel: 010-51715999

Fax: 010-51413399

4008-111-000

www.ruijie.com.cn



A 11

