

C

# RG-WS7880

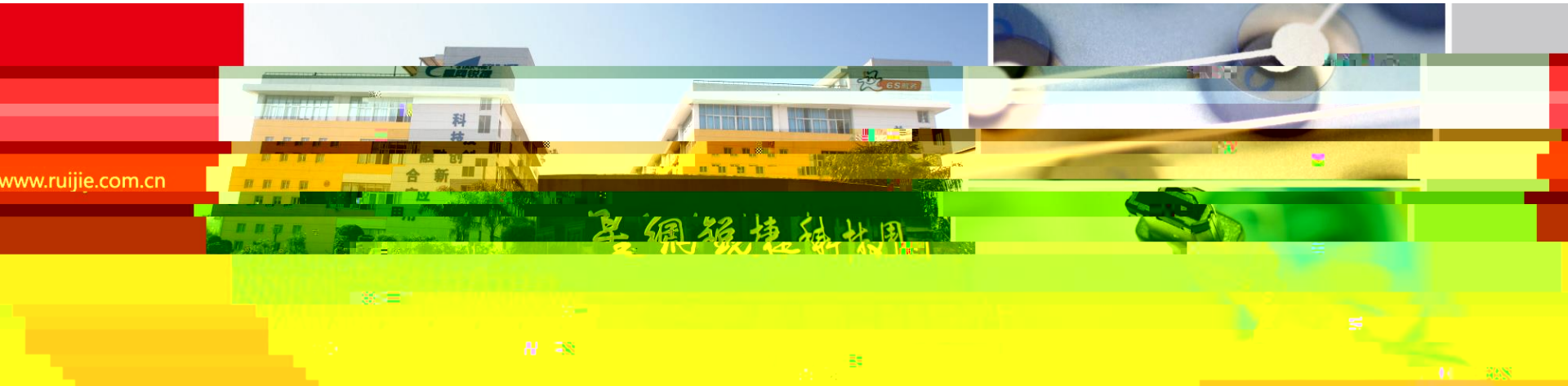

# 目录 Contents

1

2

3

4

WS7000系列特性

WS7000系列特性

WS7800系列特性

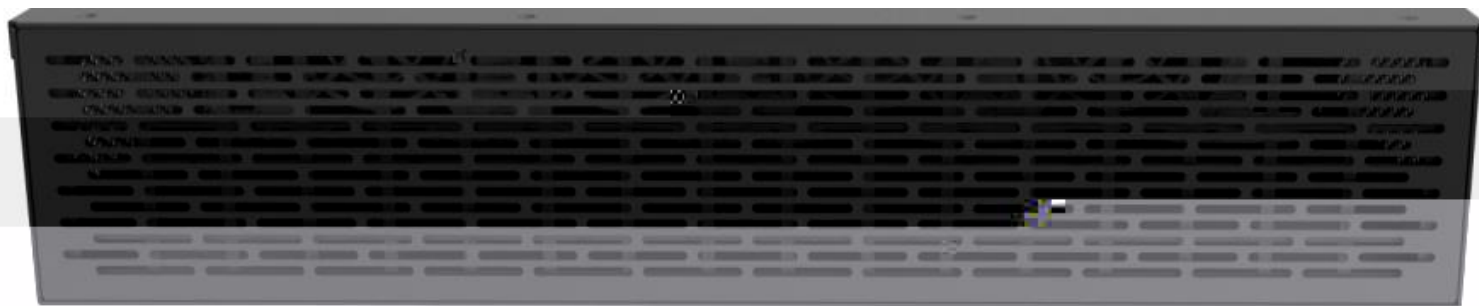
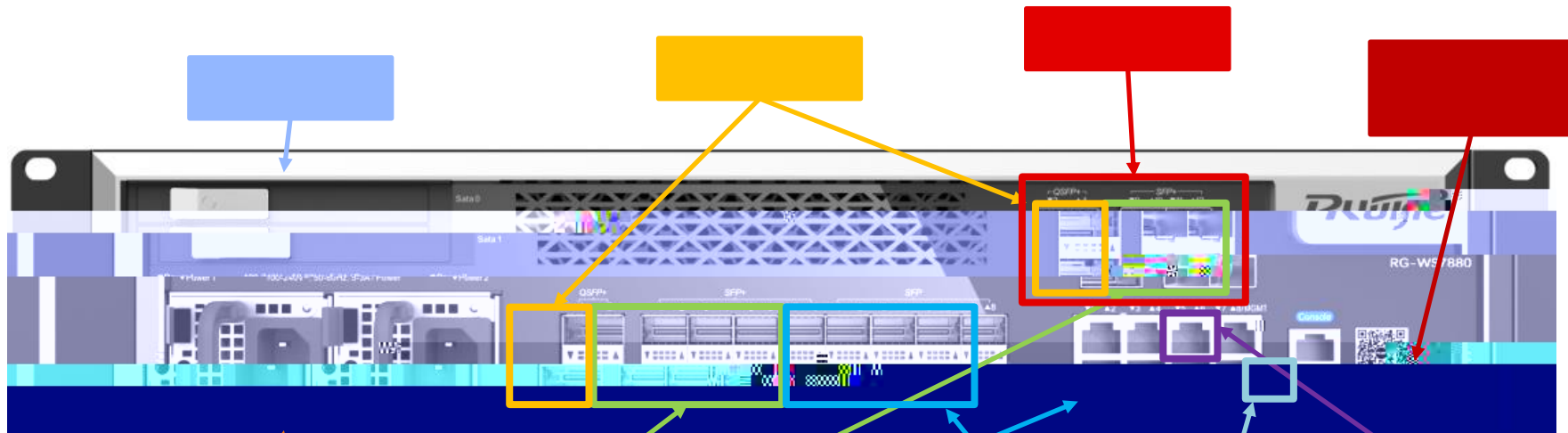

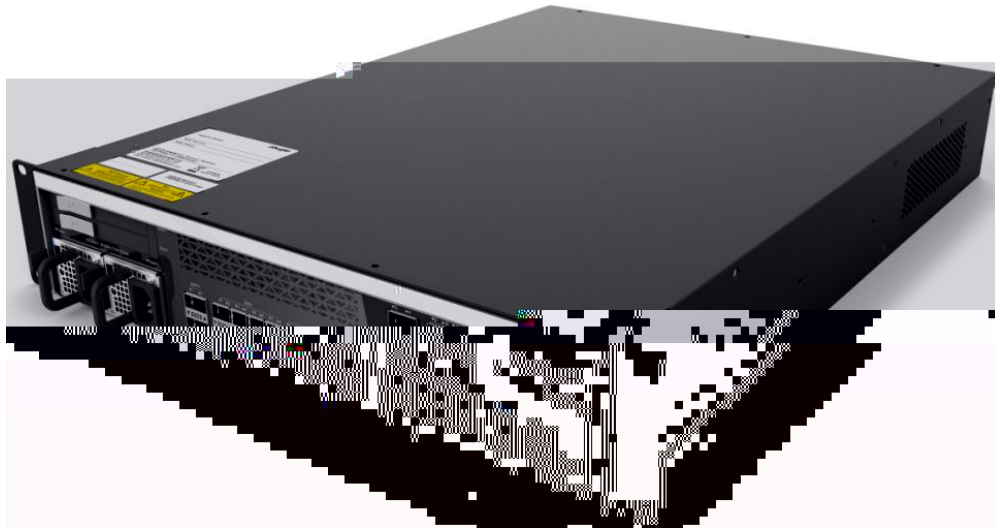

RG-WS7880

2 3

RG-WS7880

WS7880

40Goe

AC ? ô

AC

I

"

AC"

CPU48    DDR4 SDRAM 32G    BOOTROM:8MB    Flash  
eMMC(16GB+64GB)

		8
	0/1	

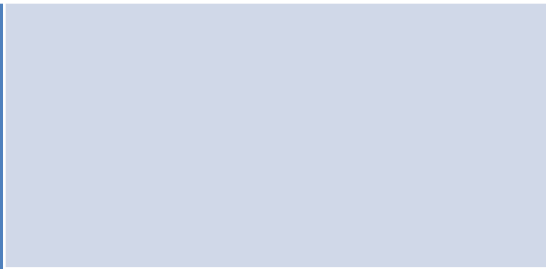
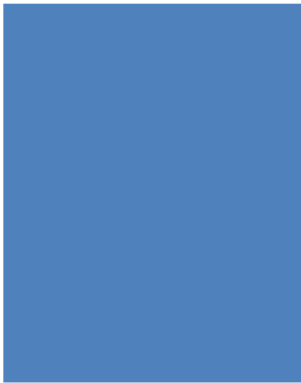

- ✓
- ✓
- ✓
- ✓
- ✓
- ✓
- ✓

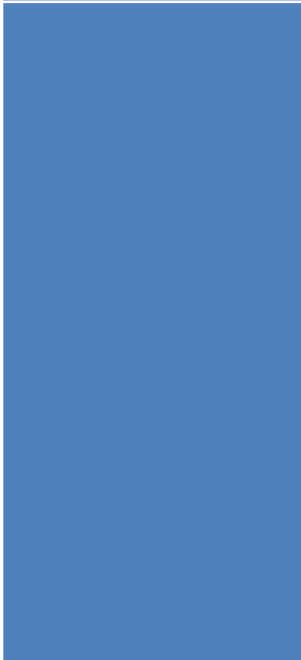
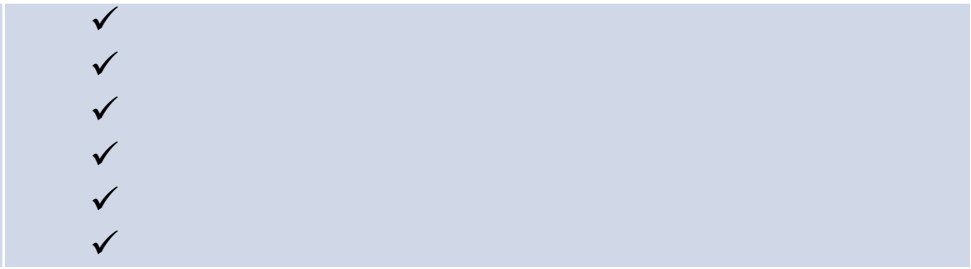

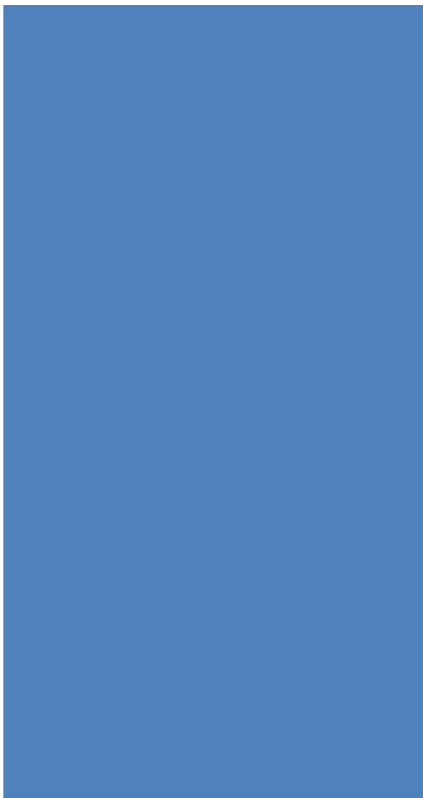



# 目录 Contents



WS7880

2QXS4XS

WS7880

■ WS7880

AC

■ AC

■ AC

802.11ac Wave2

■

■

AC Master AC

■

■ AC

# 目录 Contents

1

2

3

4

WIC7000 接口特性

WS7800 接口特性

WS7800 接口特性

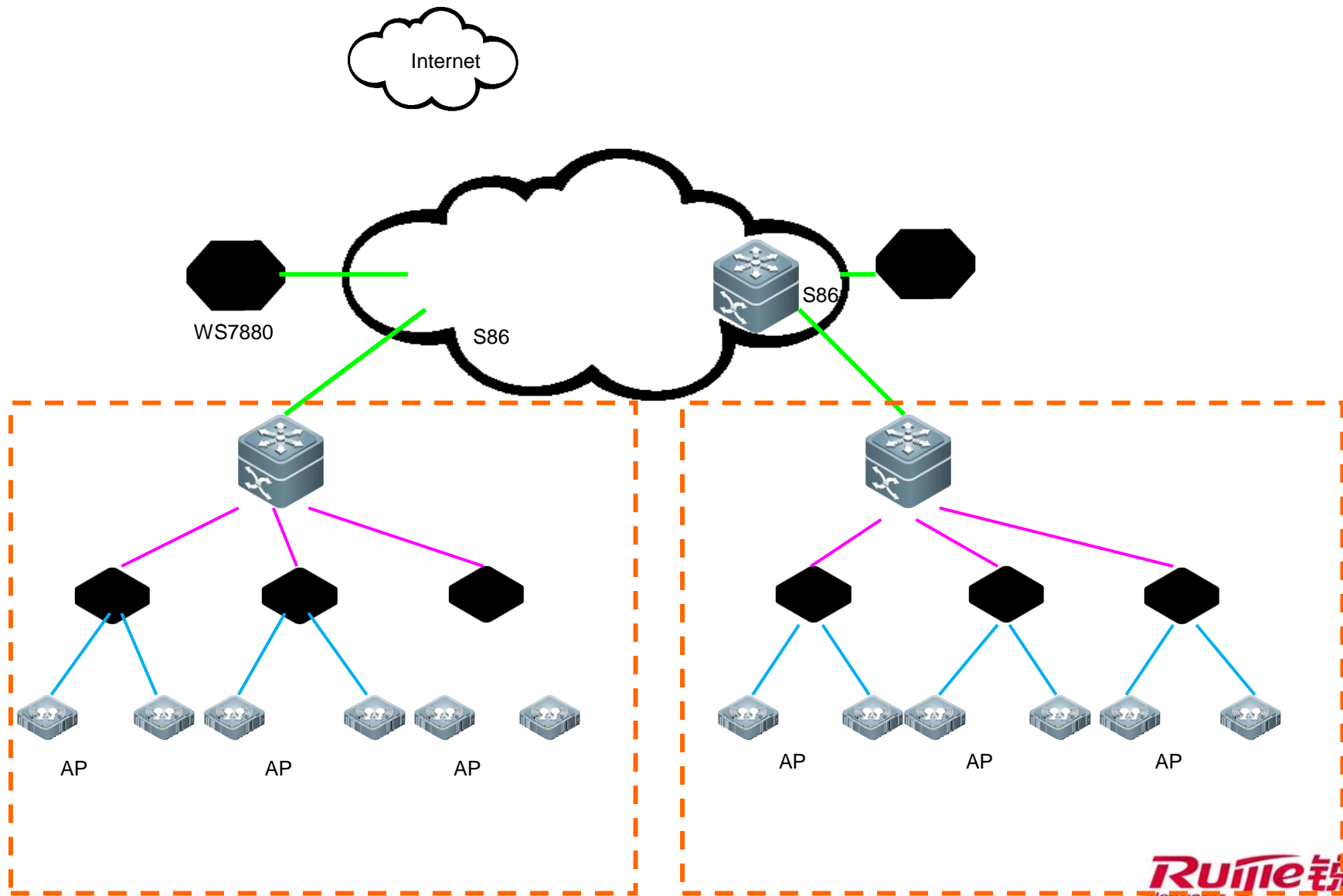

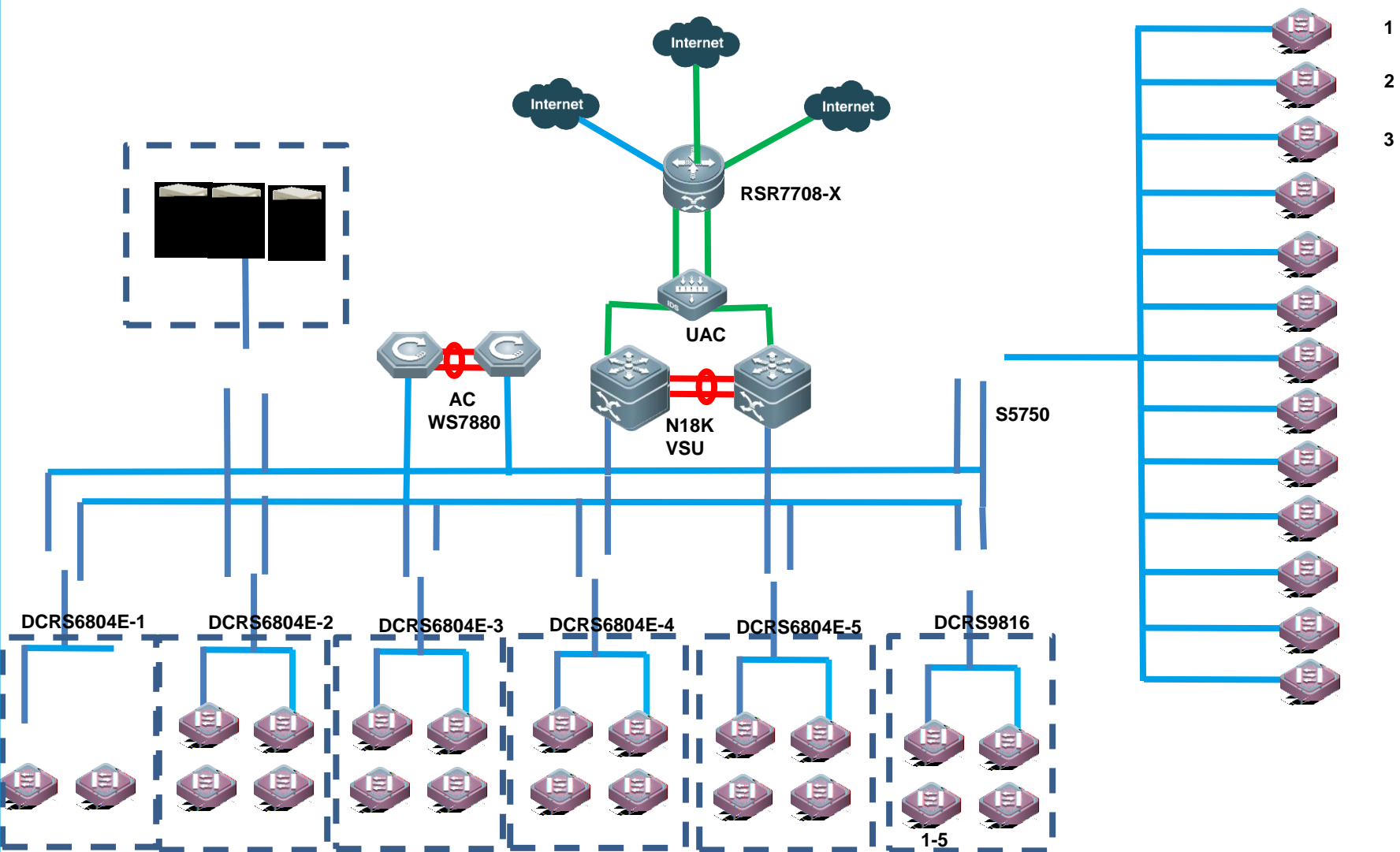

# 目录 Contents

1

2

33

WS7800软件配置

# WS7880

- 40G (config)# split interface interface-type interface-number

```
WS7880#sh run
WS7880#sh running-config
Building configuration...
Current configuration: 45052 bytes

version 4C R05:11.9(0)B1, Release(051226)B0...
Mgmt int= GigabitEthernet0/0/0/0
...

```

```
TenGigabitEthernet 1/0/1 up Full 10G fiber
TenGigabitEthernet 1/0/2 up Full 10G fiber
TenGigabitEthernet 1/0/3 down 1 Unknown Unknown fiber
TenGigabitEthernet 1/0/4 down 1 Unknown Unknown fiber
TenGigabitEthernet 1/0/5 down 1 Unknown Unknown fiber
TenGigabitEthernet 1/0/6 down 1 Unknown Unknown fiber
TenGigabitEthernet 1/0/7 down 1 Unknown Unknown fiber
TenGigabitEthernet 1/0/8 down 1 Unknown Unknown fiber
TenGigabitEthernet 1/0/9 down 1 Unknown Unknown fiber
TenGigabitEthernet 1/0/10 down 1 Unknown Unknown fiber
TenGigabitEthernet 1/0/11 down 1 Unknown Unknown fiber
TenGigabitEthernet 1/0/12 down 1 Unknown Unknown fiber
TenGigabitEthernet 1/0/13 down 1 Unknown Unknown fiber
TenGigabitEthernet 1/0/14 up 1 Full 10G fiber
TenGigabitEthernet 1/0/15 down 1 Unknown Unknown fiber
TenGigabitEthernet 1/0/16 up 1 Full 10G fiber
TenGigabitEthernet 2/0/1 up Full 10G fiber
TenGigabitEthernet 2/0/2 up Full 10G fiber
TenGigabitEthernet 2/0/3 down 1 Unknown Unknown fiber
TenGigabitEthernet 2/0/4 down 1 Unknown Unknown fiber
TenGigabitEthernet 2/0/5 down 1 Unknown Unknown fiber
TenGigabitEthernet 2/0/6 down 1 Unknown Unknown fiber
TenGigabitEthernet 2/0/7 down 1 Unknown Unknown fiber
TenGigabitEthernet 2/0/8 down 1 Unknown Unknown fiber
TenGigabitEthernet 2/0/9 down 1 Unknown Unknown fiber
TenGigabitEthernet 2/0/10 down 1 Unknown Unknown fiber

```

- 40G (config)#no split interface interface-type interface-number

# THANKS

29

A 11

100036

Office Tel: 010-51715999 Fax: 010-51413399

[www.ruijie.com.cn](http://www.ruijie.com.cn)